

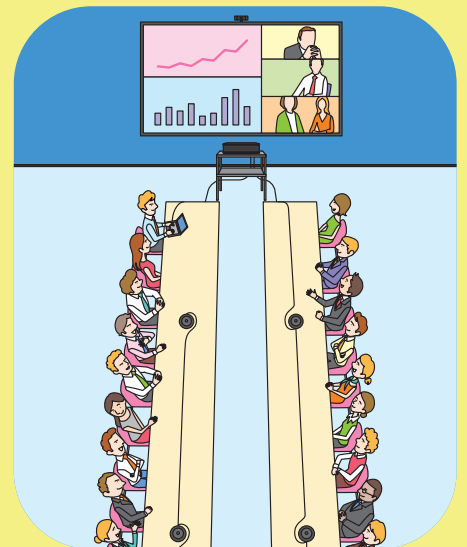

Expertly designed and developed for seamless web conferences, remote work, remote lectures, open-concept offices and more!

# Unified Communications Products

Solutions for Enhancing Communications Everywhere!

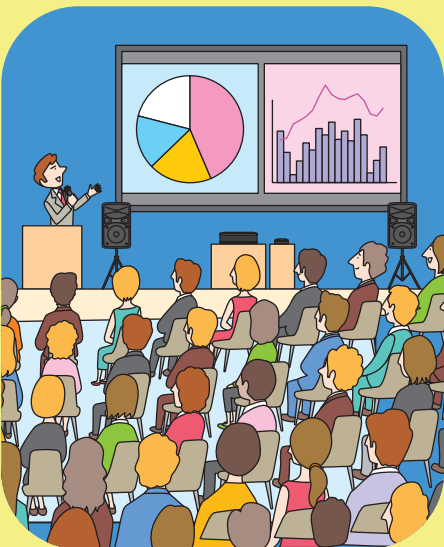

With a wide range of products and features, we offer device configurations that perfectly match your room size, group size, and situation

Yamaha Unified Communications products are used in a variety of situations, such as web conferences, remote lectures, remote medical care, and on the go workspaces. Remote collaboration happens everywhere, so such devices need to be extremely convenient as they allow for smooth communication regardless of the place. However, in order to achieve maximum efficiency and performance, the right combination of devices for the application and scale is necessary. Starting on the next page, we'd like to introduce solutions including device configurations and installation illustrations for each use case. We hope you find a combination that is perfect for you.

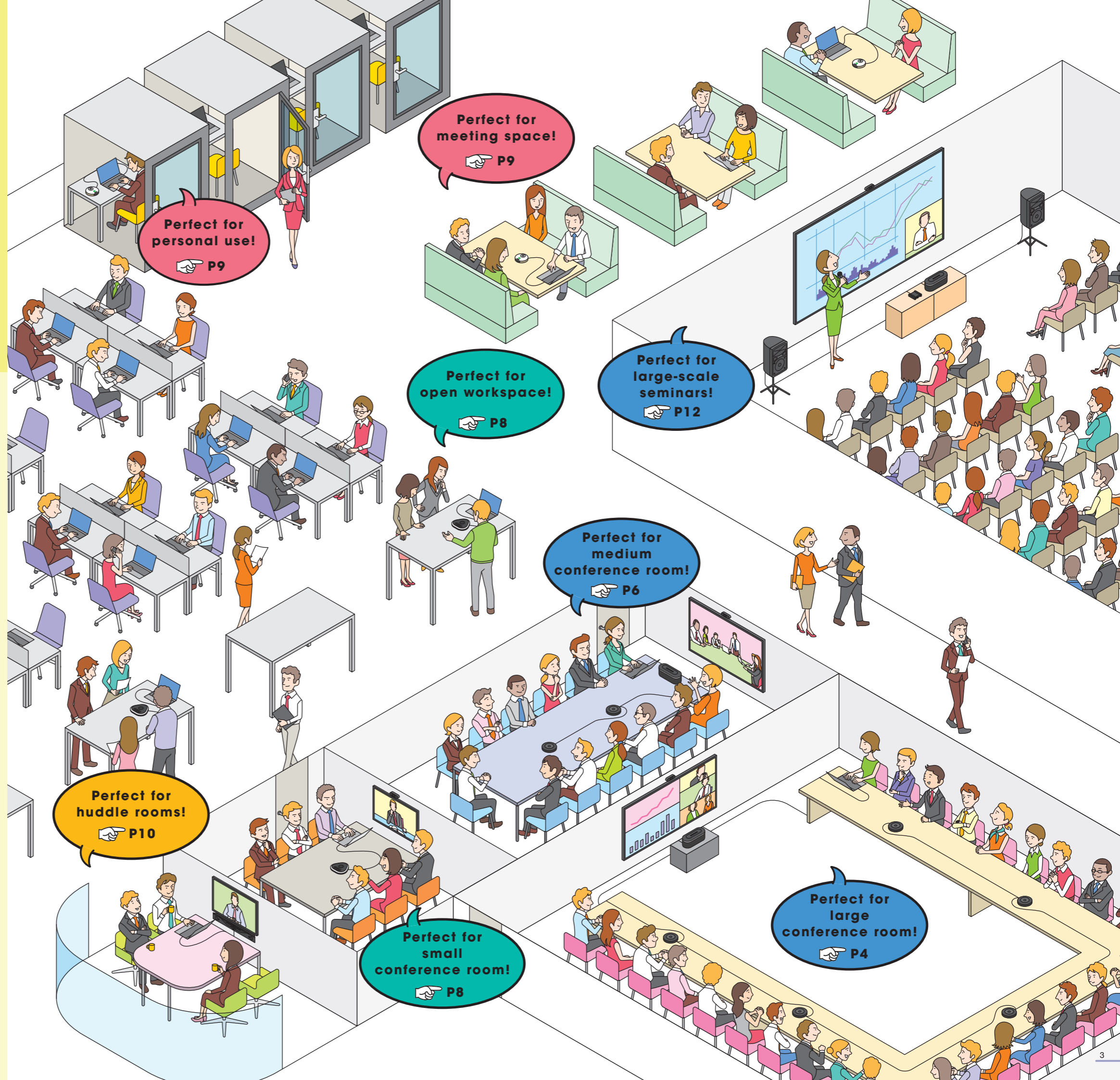



## Large Conference Room

Even with a large screen, high volume, and many participants, YVC-1000 delivers clear audio providing a teleconference that feels natural and intimate.

Large Conference Room

YVC-1000

About 30 people

### Configuration Devices (Yamaha Products)

Unified Communications Microphone & Speaker System

- 1 YVC-1000: x1 (Includes 1 microphone)

YVC-1000 Extension Microphone

- 2 YVC-MIC1000EX: x4

### Other Requirements

- 3 Powered speakers: x2
- 4 PC
- 5 Web conference software
- 6 Web camera
- 7 RCA cable  
(For connecting the YVC-1000 and the powered speakers)
- 8 Projector

### Connection Illustration

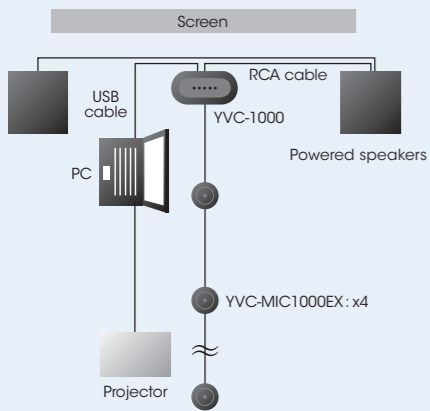

### Example Settings

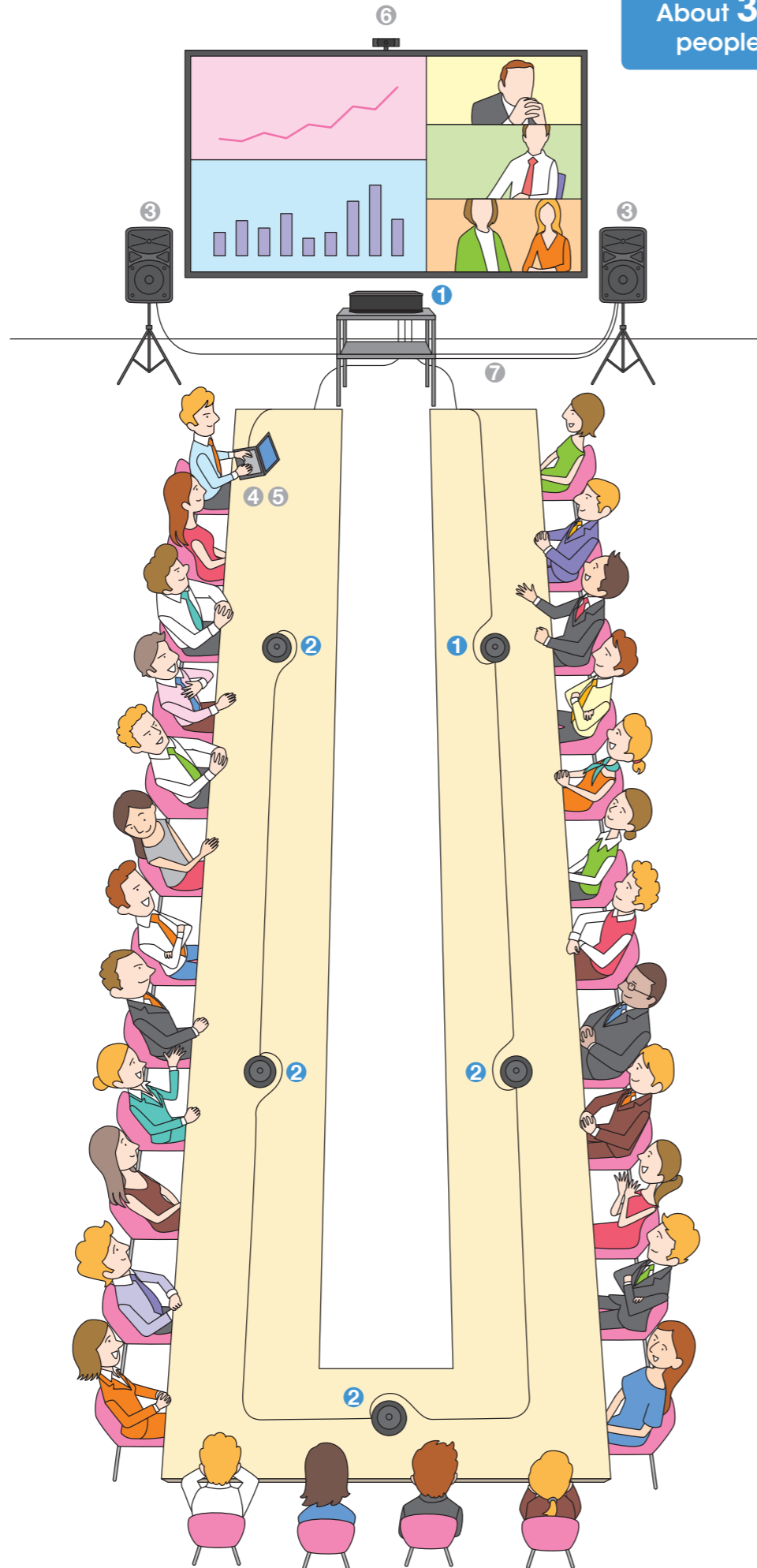
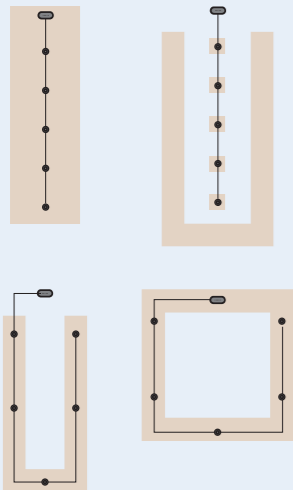

## Large Conference Room

Daisy chain extension microphones can clearly pick up sound even in large groups.

Large Conference Room

YVC-1000

About 25 people

### Configuration Devices (Yamaha Products)

Unified Communications Microphone & Speaker System

- 1 YVC-1000: x1 (Includes 1 microphone)

YVC-1000 Extension Microphone

- 2 YVC-MIC1000EX: x3

### Other Requirements

- 3 PC
- 4 Web conference software
- 5 Web camera
- 6 Display

### Connection Illustration

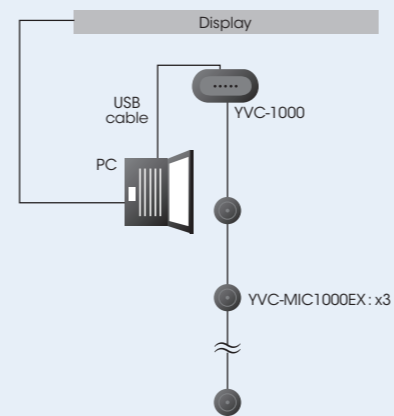

### Example Settings

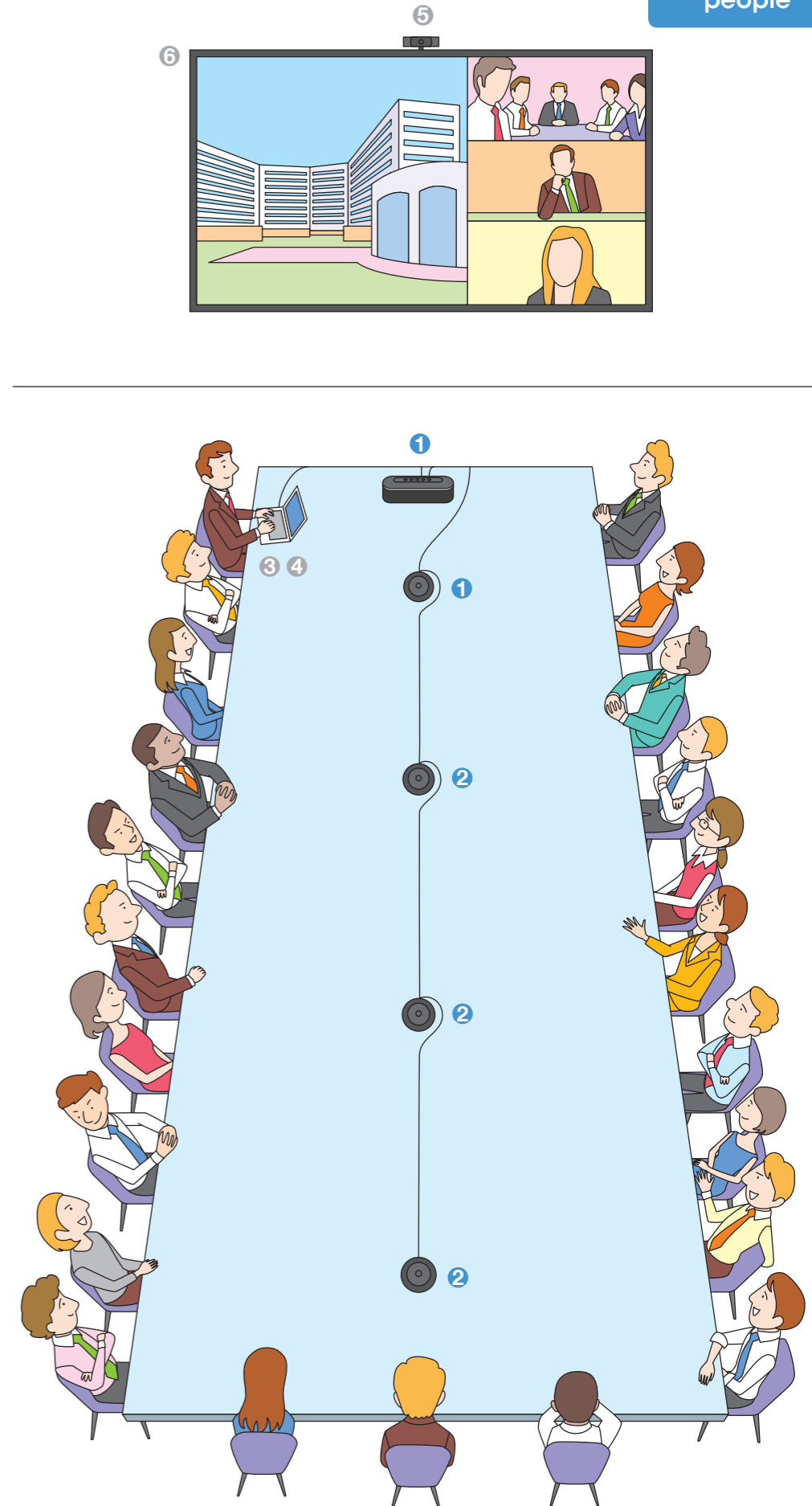
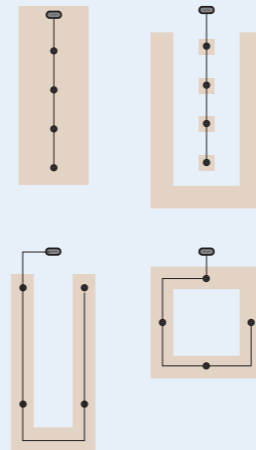

## Medium Conference Room

The built-in speaker fills the conference room with its abundant volume, achieving a natural communication.

### Configuration Devices (Yamaha Products)

- Unified Communications Microphone & Speaker System
- 1 YVC-1000: x1 (Includes 1 microphone)
  - YVC-1000 Extension Microphone
  - 2 YVC-MIC1000EX: x2

### Other Requirements

- 3 PC
- 4 Web conference software
- 5 Web camera
- 6 Display

### Connection Illustration

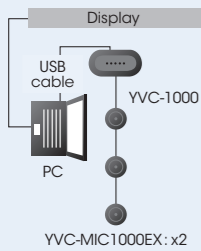

### Example Settings

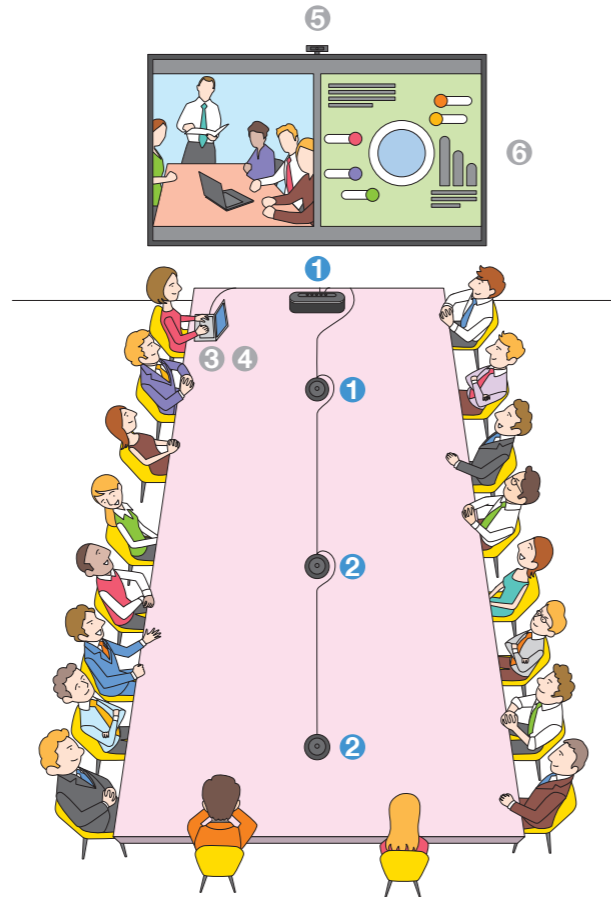
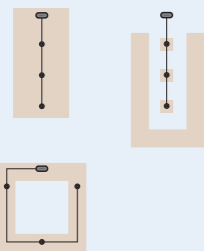

Medium Conference Room

YVC-1000

About 20 people

## Medium Conference Room

Normally, devices are used in separate small conferences, but by connecting devices together, a medium-sized conference can be held in minutes.

### Configuration Devices (Yamaha Products)

- Unified Communications Speakerphone
- 1 YVC-330: x2
  - YVC-330 Daisy Chain Cable
  - 2 YCBL-DC3M

### Other Requirements

- 3 PC
- 4 Web conference software
- 5 Web camera
- 6 Display
- 7 AC adapter (For YVC-330)

### Connection Illustration

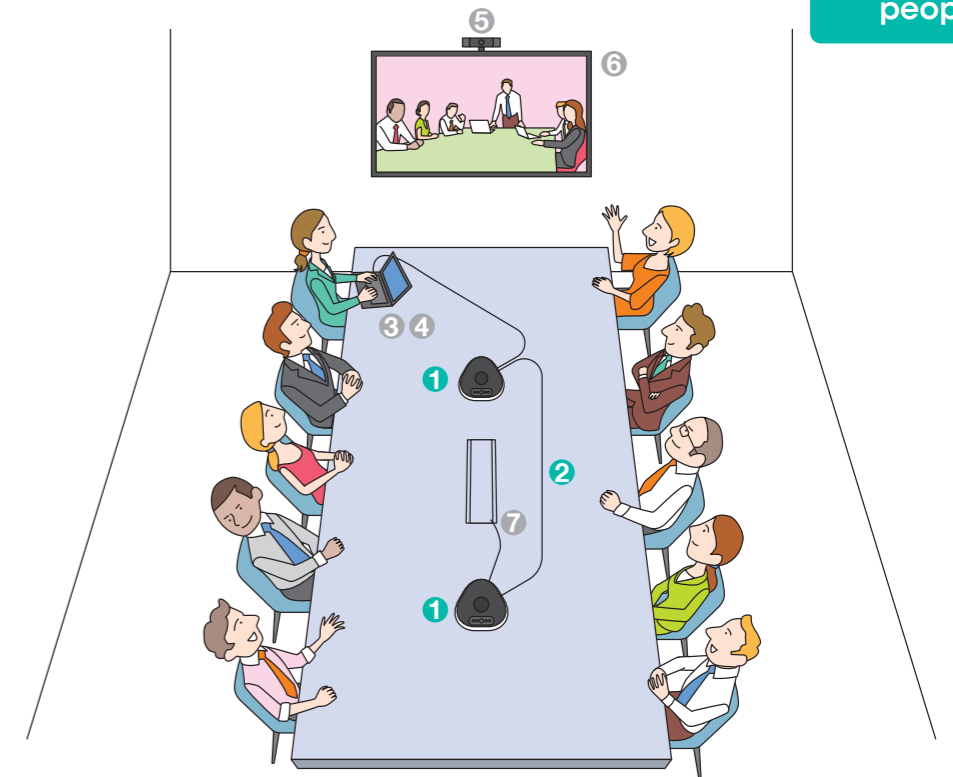
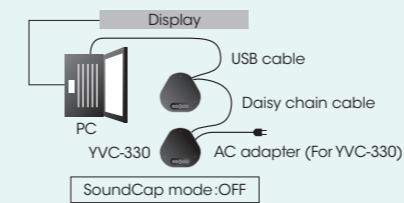

Medium Conference Room

YVC-330

About 10 people

## Medium Conference Room

The built-in speaker delivers full, clear audio to every corner of the room for a smooth conference.

### Configuration Devices (Yamaha Products)

- Unified Communications Microphone & Speaker System
- 1 YVC-1000: x1 (Includes 1 microphone)
  - YVC-1000 Extension Microphone
  - 2 YVC-MIC1000EX: x1

### Other Requirements

- 3 PC
- 4 Web conference software
- 5 Web camera
- 6 Display

### Connection Illustration

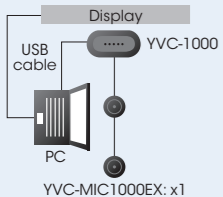

### Example Settings

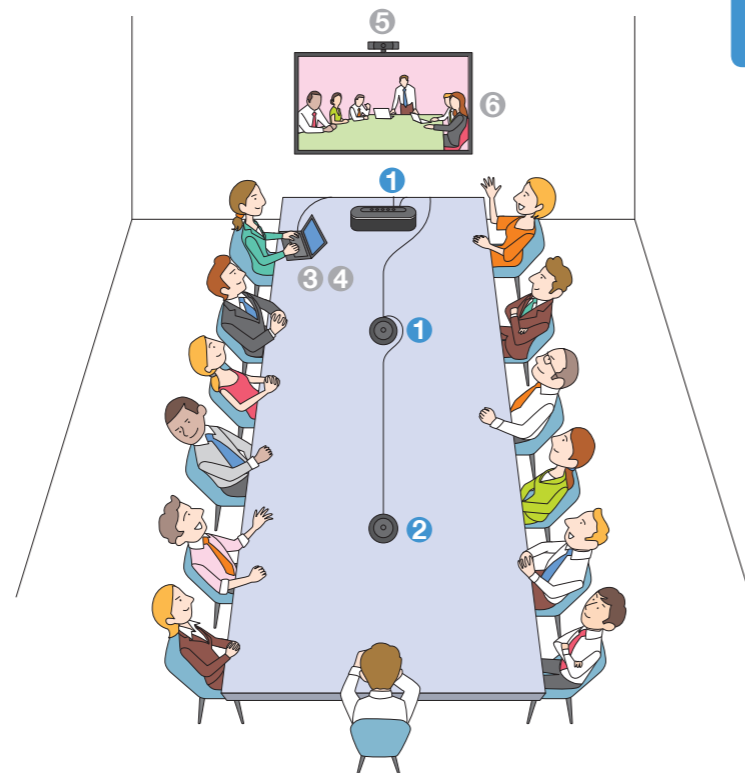
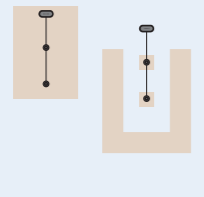

Medium Conference Room

YVC-1000

About 15 people

## Medium Conference Room

The built-in speaker's ample volume easily fills the whole room. Messages are reliably conveyed for comfortable conversation.

### Configuration Devices (Yamaha Products)

- Unified Communications Microphone & Speaker System
- 1 YVC-1000: x1 (Includes 1 microphone)

### Other Requirements

- 2 PC
- 3 Web conference software
- 4 Web camera
- 5 Display

### Connection Illustration

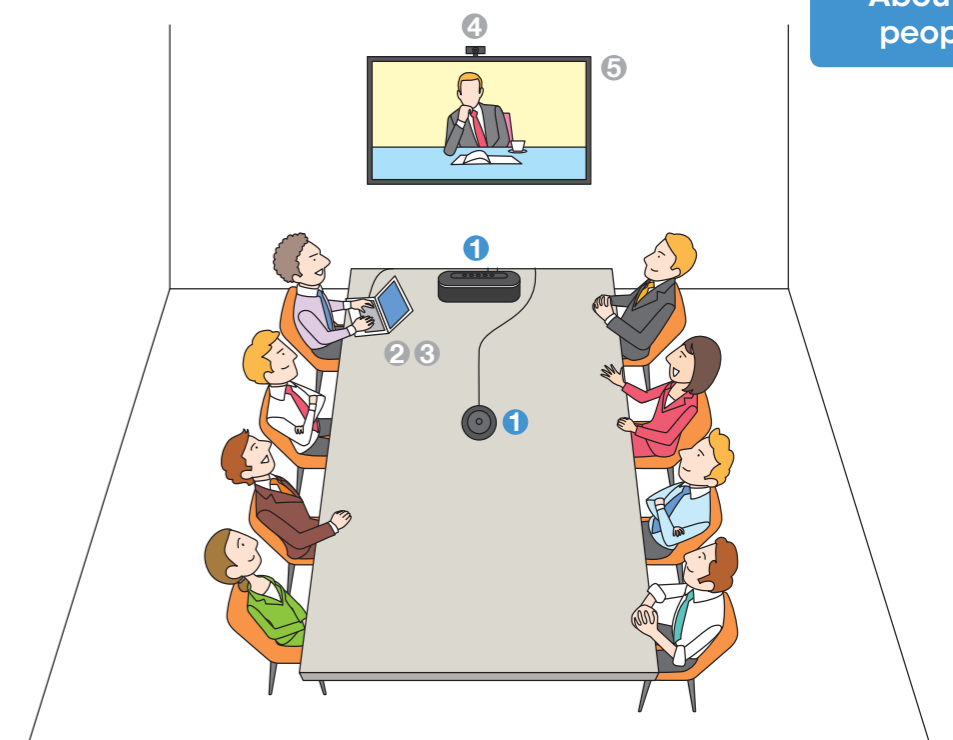
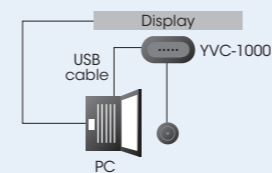

Medium Conference Room

YVC-1000

About 8 people

## Small Conference Room

The USB bus power support lets you start the conference simply by plug-n-play.

### Configuration Devices (Yamaha Products)

- Unified Communications Speakerphone
- 1 YVC-330: x1

### Other Requirements

- 2 PC
- 3 Web conference software
- 4 Web camera
- 5 Display

### Connection Illustration

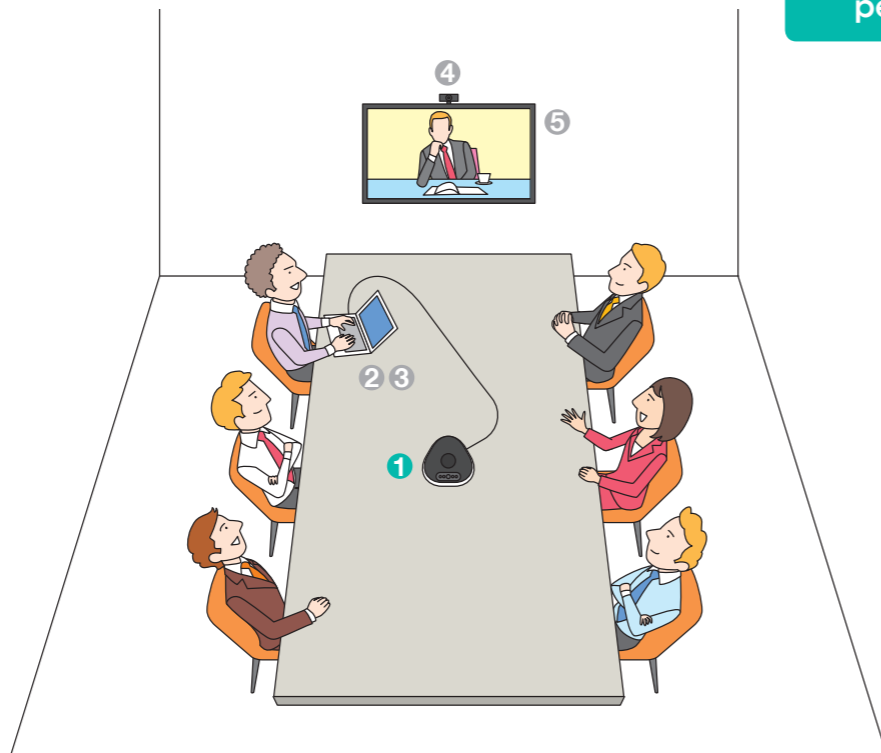
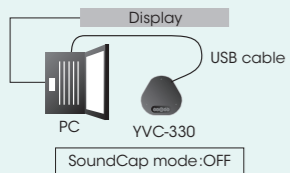

Small  
Conference Room

YVC-330

About 6  
people

## Meeting Space

Pocket-sized and battery-equipped, you can easily carry device to participate in conferences anywhere.

### Configuration Devices (Yamaha Products)

- Unified Communications Speakerphone
- 1 YVC-200: x1

### Other Requirements

- 2 PC
- 3 Web conference software
- 4 Web camera

### Connection Illustration

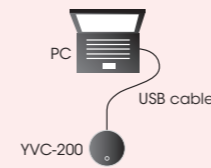

Easily hold web conferences in meeting spaces.

Meeting  
Space

YVC-200

About 4  
people



## Open Workspace

The new SoundCap function suppresses distracting noise around you. You can comfortably have conferences even in noisy open workspaces.

### Configuration Devices (Yamaha Products)

- Unified Communications Speakerphone
- 1 YVC-330: x1

### Other Requirements

- 2 PC
- 3 Web conference software
- 4 Web camera

### Connection Illustration

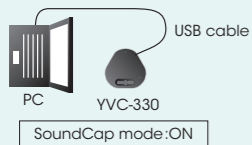

Open  
Workspace

YVC-330

About 4  
people

Allow technicians from your office participate in meetings at your customer's office.

Customer's  
Office

YVC-200

About 2  
people

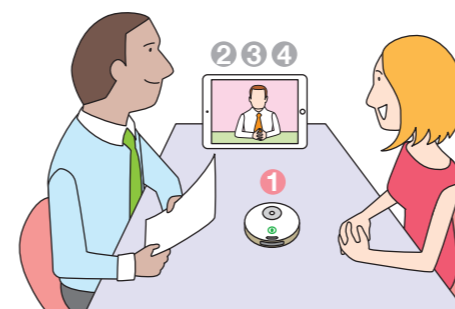

\* Connected via Bluetooth.

Enable true-to-life conferencing for your department while on a business trip or at home.

At home/  
On Business Trips

YVC-200

1  
person



Use for remote systems at information desks for financial or medical institutions.

Information  
Desk

YVC-200

1  
person



Using SoundCap makes the YVC-330 pick up sound while significantly reducing sound 1 m or more away from the device. This lets you suppress distracting noise around you to clearly deliver the voices of conference participants to the remote party.



## Huddle Room

With a single USB connect to PC, the video sound bar is good to go.

### Configuration Devices (Yamaha Products)

Video Sound Collaboration System for Huddle Rooms

- 1 CS-700AV/CS-700SP: x1

### Other Requirements

- 2 PC
- 3 Web conference software
- 4 Display

### Connection Illustration

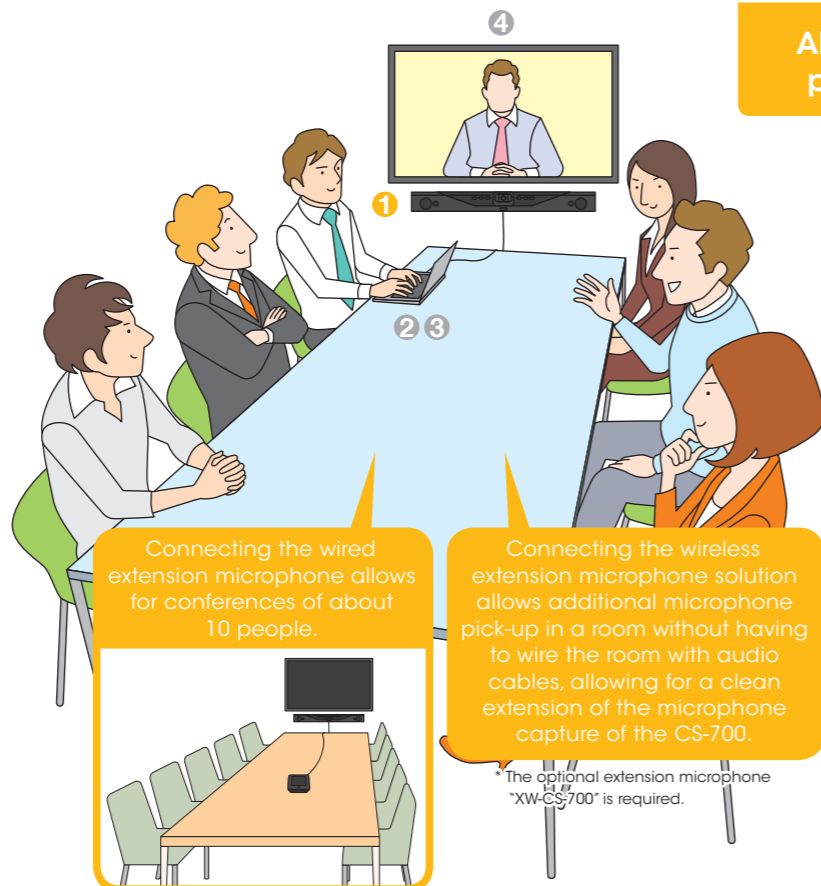
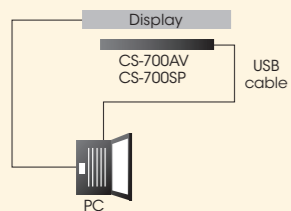

Connecting the wired extension microphone allows for conferences of about 10 people.

Connecting the wireless extension microphone solution allows additional microphone pick-up in a room without having to wire the room with audio cables, allowing for a clean extension of the microphone capture of the CS-700.

\* The optional extension microphone "XM-CS-700" is required.

Huddle Room

CS-700AV  
CS-700SP

About 6 people

## Remote Lectures

Hold remote lectures while sitting down in a classroom layout.

### Configuration Devices (Yamaha Products)

Unified Communications Microphone & Speaker System

- 1 YVC-1000: x1 (Includes 1 microphone)

YVC-1000 Extension Microphone

- 2 YVC-MIC1000EX: x4

### Other Requirements

- 3 PC
- 4 Web conference software
- 5 Web camera
- 6 Display

### Connection Illustration

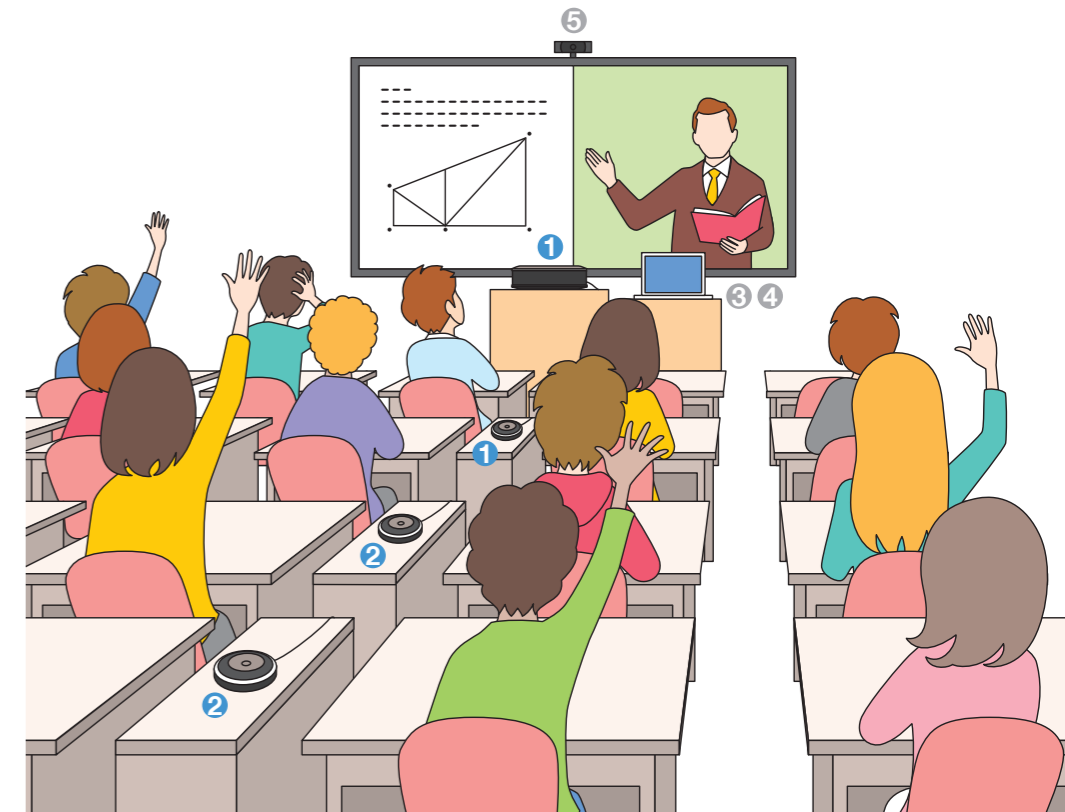
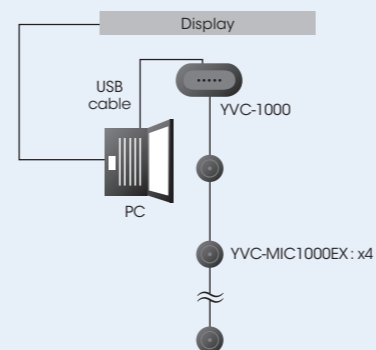

Remote Lectures

YVC-1000

About 40 people

## Huddle Room

Connect to a movable display stand to instantly hold remote conferences in a huddle space.

### Configuration Devices (Yamaha Products)

Video Sound Collaboration System for Huddle Rooms

- 1 CS-700AV/CS-700SP: x1

### Other Requirements

- 2 PC
- 3 Web conference software
- 4 Display
- 5 Display stand

### Connection Illustration

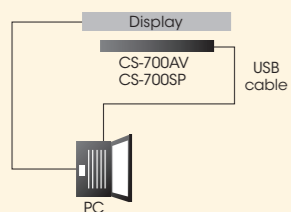

Huddle Room

CS-700AV  
CS-700SP

About 6 people

## Remote Lectures

Gather together up front for remote lectures focusing on interaction.

### Configuration Devices (Yamaha Products)

Video Sound Collaboration System for Huddle Rooms

- 1 CS-700AV/CS-700SP: x1

### Other Requirements

- 2 PC
- 3 Web conference software
- 4 Display

### Connection Illustration

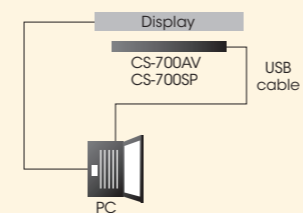

Remote Lectures

CS-700AV  
CS-700SP

About 20 people

## Lecture Hall/Seminar Room

Hold remote lectures or remote seminars without purchasing expensive equipment. Connecting an external hand-held microphone lets you amplify your voice for those in the room while also transmitting your voice to the remote location.

Lecture Hall/  
Seminar Room

YVC-1000

About 200  
people

### Points

- You can transmit lectures or seminars to remote locations without purchasing large-scale expensive equipment.
- By connecting an external hand-held microphone, you can amplify the presenter's voice for those in the room while simultaneously delivering it to the remote location.
- Since you can connect 2 external microphones, you can use them for various applications, such as having the presenter hold one, and having attendees use the other.

### Configuration Devices (Yamaha Products)

Unified Communications Microphone & Speaker System

- 1 YVC-1000: x1 (Includes 1 microphone)

### Other Requirements

- 2 Powered speakers: x2
- 3 Wireless microphone system
- 4 PC
- 5 Web conference software
- 6 Web camera
- 7 Projector
- 8 RCA cable (For connecting the YVC-1000 and the powered speakers)
- 9 RCA-phone cable (For connecting the YVC-1000 and the wireless microphone system)

### Connection Illustration

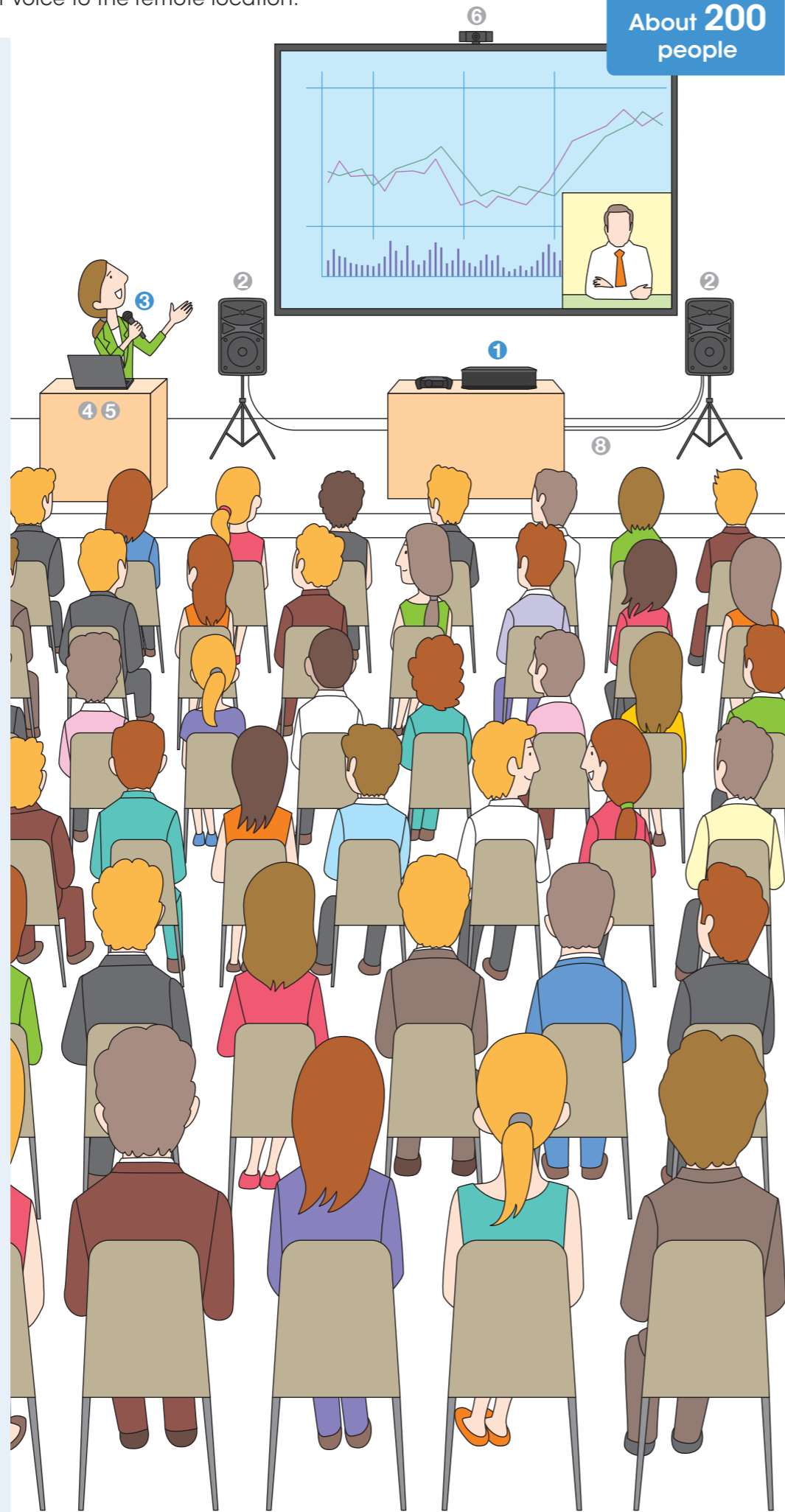
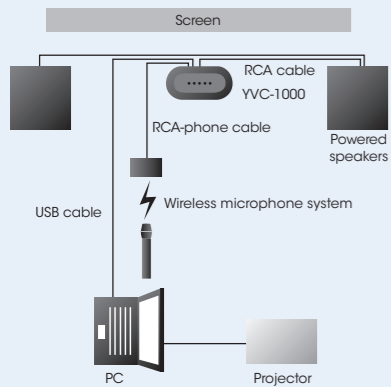

## Techniques for Using the YVC-1000

To hold a true-to-life teleconference, remote seminar, or remote lecture.

Use the hand-held microphone to deliver your voice to the whole hall.

### <External Microphone Connection>

Connecting a hand-held microphone to the YVC-1000's audio input terminals allows you to output the presenter's voice from the YVC-1000's built-in speaker. Of course, their voice is also transmitted to the remote location.

#### Required Equipment

Wired or wireless hand-held microphone

\*See our homepage for verified devices.

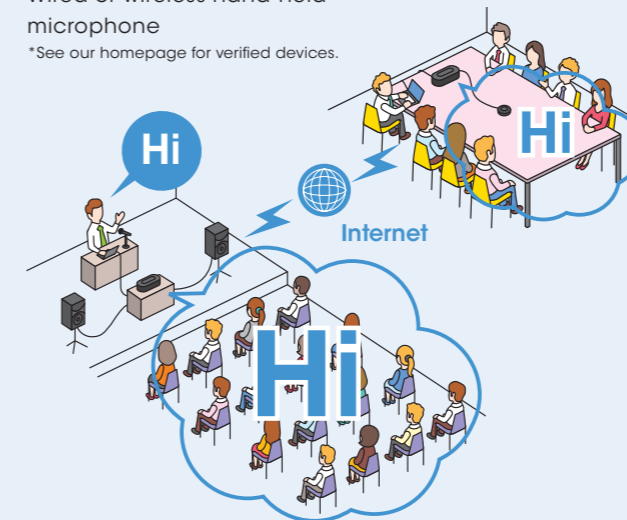

Connecting a hand-held microphone lets you transmit your voice to the remote location while amplifying the presenter's voice in your location.

Connect speakers to deliver the high-volume conversations to the hall.

### <External Speaker Connection>

Connecting speakers with built-in amplifiers to the YVC-1000's external speaker terminals allows you to hold teleconferences with higher volume. This enables you to deliver the voice from the remote location to large groups evenly, even in large halls.

#### Required Equipment

Speakers with built-in amplifiers / Mixer with built-in amplifiers + speakers

\*See our homepage for verified devices.

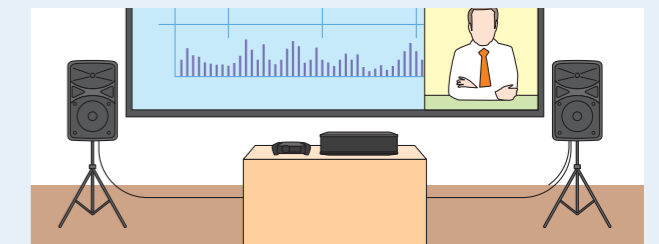

#### Conventional System

Connecting many devices to construct a sound system

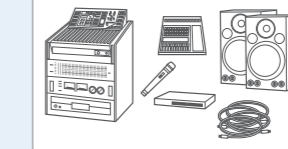

#### YVC-1000

Simple configuration for easy use

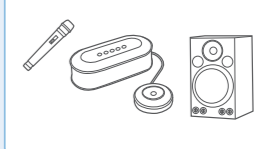

### Convenient at times like this!

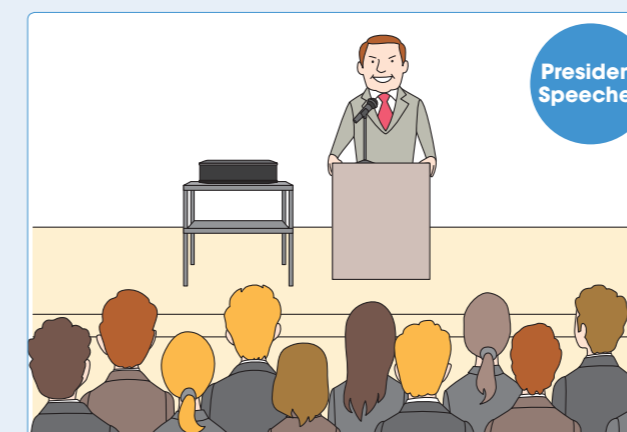

Deliver president speeches and share the vision and goals with the whole company at once.



Live the employee training to multiple locations simultaneously.

Speakerphone			Video Sound Bar
<b>8 to 40 people</b>	<b>4 to 10 people</b>	<b>1 to 4 people</b>	<b>6 to 10 people</b>
<b>YVC-1000</b>	<b>YVC-330</b>	<b>YVC-200</b>	<b>CS-700AV/CS-700SP</b>
			
			

Illustration of Usage Scope\*

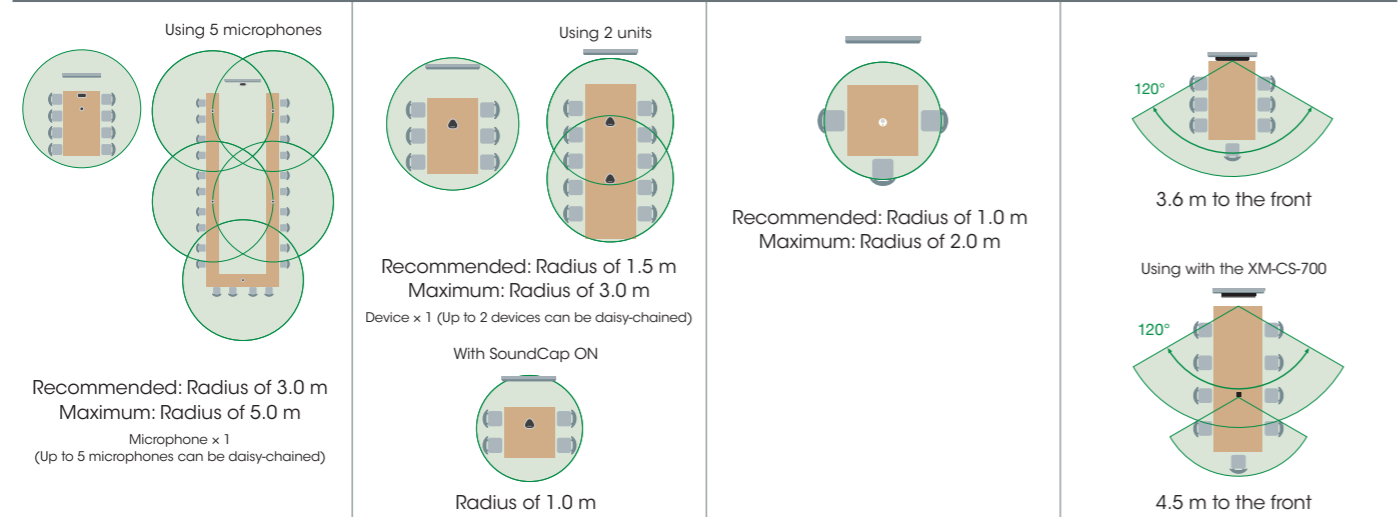

Characteristics

<ul style="list-style-type: none"> <li>With the microphone and speaker separated, you can put them in their respective optimal positions to better unify the video and audio</li> <li>Up to 4 extra microphones can be added (for a total of 5) and an external microphone &amp; speaker can be connected to support use in various locations and situations</li> </ul>	<ul style="list-style-type: none"> <li>Equipped with 2 modes to fit usage in both quiet conference rooms and noisy open workspaces</li> <li>Up to 2 units can be linked with a daisy chain connection for use in conference rooms to support conferences with about 10 people</li> </ul> <p>*SoundCap mode is not available when using a daisy chain connection.</p>	<ul style="list-style-type: none"> <li>Convenient and portable size, built-in battery, easy to use with smart devices</li> <li>Available in 2 colors to fit your own unique workstyle</li> </ul>	<ul style="list-style-type: none"> <li>Equipped with an 120°+ wide field of vision, high-resolution camera to fully convey the expressions of conference participants</li> <li>Supports various installation methods and can be installed on the wall for a well-organized huddle room</li> </ul>
---	--	--	---

Expandability

Extension microphone, external microphone & speaker	Daisy chain up to 2 devices	No	Extension microphone (wired/wireless)
---	-----------------------------	----	---------------------------------------

Power Source

AC power source	USB bus powered	Built-in lithium-ion battery (continuous conversation time of 10 hours) / USB bus powered	AC power source
-----------------	-----------------	---	-----------------

\*The pick-up range may vary depending on the usage environment and conditions.



## Product Information



Unified Communications Microphone & Speaker System  
**YVC-1000**



Unified Communications Speakerphone  
**YVC-330**



Black



White

Unified Communications Speakerphone  
**YVC-200**



Video Sound Collaboration System for Huddle Rooms  
**CS-700AV/CS-700SP**

\* Please ask your local contacts about the available lineup and solution of CS-700.

## Options



YVC-1000 Extension Microphone  
**YVC-MIC1000EX**



YVC-330 Daisy Chain Cable  
**YCBL-DC3M**





CS-700 Wired Extension Microphone  
**XM-CS-700**



CS-700 Wireless Extension Microphone  
**XW-CS-700**

### About trademarks

- Bluetooth and  are registered trademarks of the Bluetooth SIG, Inc. and are used by Yamaha Corporation in accordance with a license agreement.
- "N-Mark"  is a trademark or registered trademark of NFC Forum, Inc.
- Android is a trademark of Google Inc.

YAMAHA CORPORATION