

PS753

Document Camera

User Manual - English

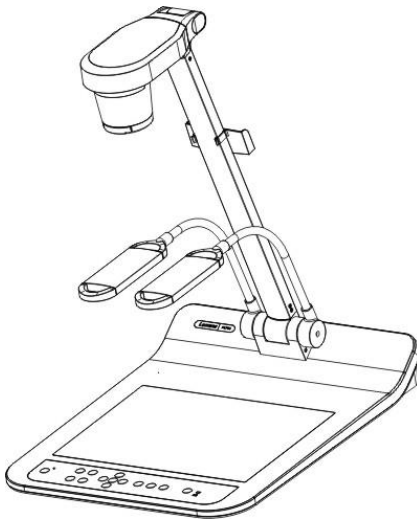

[Important]

To download the latest versions of the Quick Start Guide, multilingual user manual, software, driver, etc., please visit Lumens

<https://www.MyLumens.com/support>

Table of Contents

Chapter 1 Package Contents.....	2
Chapter 2 Product Overview.....	3
2.1 Relative Operation Position	3
Chapter 3 Installation and Connections	4
3.1 System diagram	4
3.2 Installing Application Software.....	5
Chapter 4 Start Using	6
Chapter 5 Control Panel/Remote Control and Setting Menu	7
5.1 Functions of control panel and remote control.....	7
5.2 Setting Menu.....	9
Chapter 6 Descriptions of Major Functions	14
6.1 Automatically adjust the image to have the best brightness and focusing performance	14
6.2 Switch Image Sources	14
6.3 Make text clearer and photos more colorful	14
6.4 Rotate Image.....	14
6.5 Capture Image.....	14
6.6 Record	14
6.7 View captured/recorded images.....	15
6.8 Delete captured/recorded images	15
6.9 Adjust the output volume	15
6.10 Automatically delete the stored images whenever it is turned off (Auto Erase)	15
6.11 Enlarge a part of the image (PAN)	15
6.12 I would like to use the MASK and Spotlight function	15
6.13 Play the slides (Slide Show).....	16
6.14 Use a USB disk	16
6.15 Image comparison (to compare live images with stored image files (PIP)).....	17
6.16 Lock/Unlock keys.....	17
6.17 Change the power on image	17
Chapter 7 Network Function Settings Description	18
Chapter 8 Connecting to Microscope	28
Chapter 9 Packing the Machine	29
Chapter 10 DIP Switch Setting	30
Chapter 11 Troubleshooting.....	31
Chapter 12 Safety Instructions.....	33
Supplier's Declaration of Conformity 47 CFR § 2.1077 Compliance Information	35
Appendix 1 Power frequency for each country in the world.....	36
Appendix 2 Resolution Comparison	38
Copyright Information	40

Chapter 1 Package Contents

PS753



Remote Control



**4-Step
Instruction Card**



Power Adapter

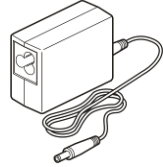

Power Cord



Appearance may vary depending on country/region

VGA cable



HDMI cable * 2



USB 2.0 cable

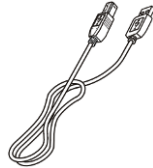

Audio Cable



**Microscope
Adapter**

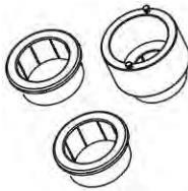

**Remote Control
Holder**

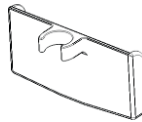

Chapter 2 Product Overview

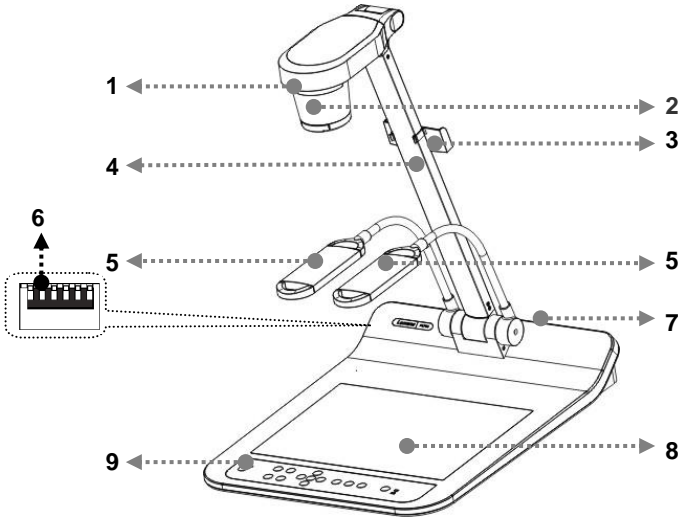

- | | |
|--------------------------------------|--------------------------|
| 1. Remote sensor | 2. Lens |
| 3. Camera arm | 4. Remote Control Holder |
| 5. Auxiliary floodlight and lamp arm | 6. DIP Switch Setting |
| 7. Input/output port | 8. Backlight |
| 9. Control panel | |

2.1 Relative Operation Position

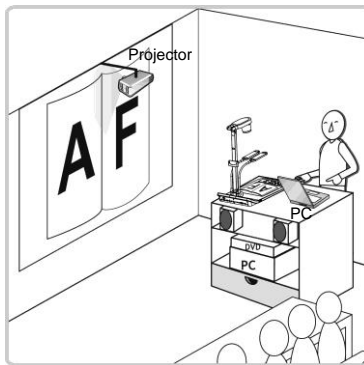

Chapter 3 Installation and Connections

3.1 System diagram

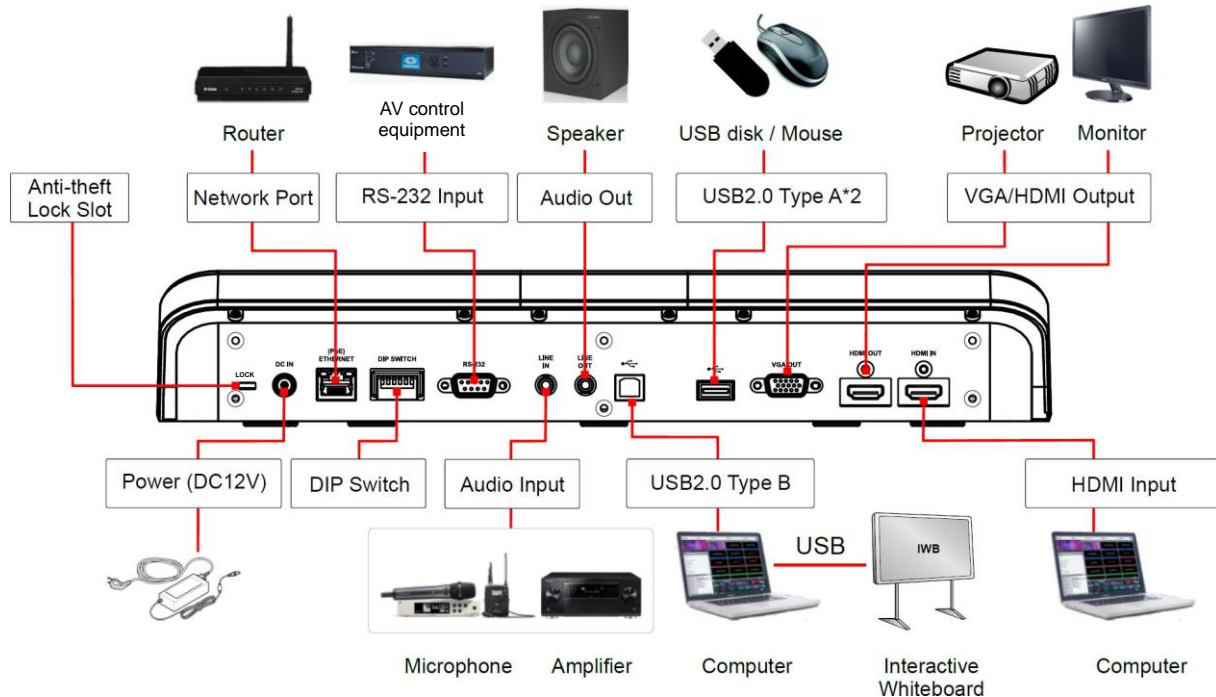

※ Press the [SOURCE] button to switch between PS753 real-time image and HDMI IN image sources

3.2 Installing Application Software

The Lumens Ladibug application software installed on the computer enables you to:

- Control the PS753.
- Capture and record images.
- Annotate the image, highlight important details and save it.
- Support the full screen function.



※ Please refer to [Ladibug™ software user manual](#) for software installation steps and operation.

- Windows: [Ladibug 4K Software User Manual](#)
- MAC: [Ladibug 3.0 Software User Manual](#)

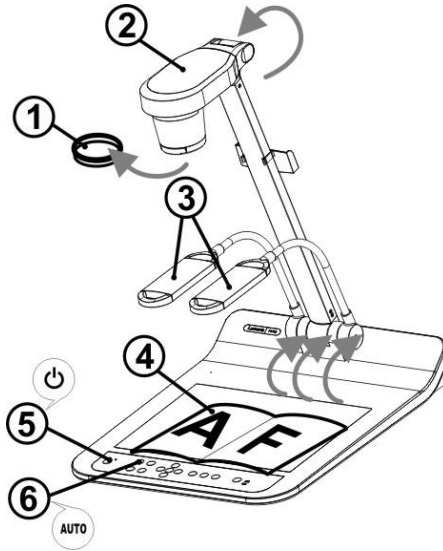
Chapter 4 Start Using









※ Please adjust to the local voltage frequency of 50/60 Hz. For the frequency in actual use, please refer to [Appendix 1 power frequency for each country in the world](#) in the manual.





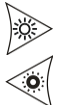



1. Remove the lens cap.
2. Pull up the camera and the camera arm. The camera should aim at the center of the presenter.
3. Pull up the lamp arm to a proper position.
4. Place an object to be displayed under the camera.
5. Press [POWER]  on the **remote control** or **control panel** to power on.
6. Press **control panel** [AUTO TUNE]  button to optimize the image.
You are ready to teach/present.
7. Each time the lens is moved, press [AUTO TUNE]  on the **remote control** or **control panel** to refocus.
 - According to your request, you can adjust the camera head slightly to aim at the center of the documents when the anchor of lens was reached.
 - When using the remote control, aim at the remote sensor on the PS753, and press the power button.
 - Once PS753 is turned on, the LED on the control panel will flash a few times and stay lit. Please contact your distributor if the LED does not light up.

Chapter 5 Control Panel/Remote Control and Setting Menu

5.1 Functions of control panel and remote control

<Remark> The below functions are listed alphabetically

Icon	Name	Function Descriptions	Operation
	Power	Power on and off Press and hold for 5 ~ 10 seconds to turn off	Remote control/ Control panel
	Arrow Key	Move up, down, left or right to select the needed function	Remote control/ Control panel
	AUTO TUNE	Automatically adjust the image to have the best brightness and focusing performance	Remote control/ Control panel
	BRT+/-	Adjust the brightness of the image	Remote control/ Control panel
	CAPTURE /DEL	Capture and save images to USB disk (priority) or internal memory card while displaying live images Delete files from the USB disk (priority) or internal memory card while reading the stored files (in Playback mode)	Remote Control
	ENTER	Activate/Enter functions	Remote Control
	LAMP	Lamp mode toggle switch (Arm lamp/Backlight/Off the lamp)	Remote control/ Control panel
	MASK	Activate Mask/Spotlight mode	Remote Control

















	MENU	Activate the setting menu/exit the menu	Remote control/ Control panel
	PAN	Enable/Disable the partial enlarged mode	Remote Control
	PIP	Image comparison (to compare live images with stored image files)	Remote Control
	PLAYBACK	Read files in the USB disk (priority) or internal memory card	Remote control/ Control panel
	RECORD	Record motion images	Remote Control
	ROTATE	Rotate the image 0°/180°/Vertical flip/Horizontal flip/90°/270°	Remote Control
	SOURCE	Switch the input source between live image (default) or HDMI image	Remote control/ Control panel
	ZOOM +/-	Increase or decrease the image size	Remote control/ Control panel

5.2 Setting Menu

5.2.1 Main menu

Press [MENU] on the **remote control** or **control panel** to display the setting menu.



	Auto Tune Automatically adjust the image to have the best brightness and focusing performance.		Playback Preview the photos or videos stored in the USB disk (priority) or internal memory card.
	PAN Enable/Disable the partial enlarged mode.		Manual Focus Manual Focus.
	LAMP Lamp mode toggle switch.		Rotate Screen rotation 0°/180°/Vertical flip/Horizontal flip/90°/270°.
	PIP Compare live images with stored images.		Settings Set up various functions.
	Brightness Adjust the brightness of the image.		Photo/Text Select Photo/Text/Gray Mode.
	Mask Activate the mask mode.		Annotation Annotate or mark the image.
	Zoom Increase or decrease the image size.		Mode Select image mode.
	Spotlight Activate the spotlight mode.		Exit Exit the setting menu.

5.2.2 Setting menu

1st Level Major Items	2nd Level Minor Items	Function Descriptions
Capture	Capture Mode	Use the left and right arrow keys to select the capture mode Single Capture/Time Lapse/Record/Off
	Capture Time	Use the left and right arrow keys to select the capture time. The setting range is 1 ~ 72 hours * This will be active only when capture mode is set to time lapse
	Capture Interval	Use the left and right arrow keys to select the capture interval. The setting range is 3 ~ 5 minutes * This will be active only when capture mode is set to time lapse
	Image Quality	Use the left and right arrow keys to select the image quality for the captured images and recorded videos
	Date & Time	Set SNTP server and manually set system time
	Stream	Select Ethernet or USB function * Ethernet/USB may only choose one, because they cannot be output at the same time
Storage	Slide Show	Show the photos or videos stored in the USB disk (priority) or internal memory card in slide mode
	Delay	Use the left and right arrow keys to select the delay time The range is 0.5 seconds ~ 10 seconds, use manual mode to switch manually
	Copy To USB Disk	Use the left and right arrow keys to select, and then press [ENTER] to confirm to copy files from internal memory card to USB disk
	Delete All	Use the left and right arrow keys to select, press [ENTER] to confirm the deletion of all images from the USB disk (priority) or internal memory card
	Format	Use the left and right arrow keys to select, and then press [ENTER] to format the USB disk (priority) or internal memory card

Control	Auto Exposure	Regardless of outside environment, the machine will adjust the brightness to the optimal condition
	Auto White Balance	Regardless of outside light or color, the machine will adjust the color to the optimal condition; Press [ENTER] to execute
	Audio Out Volume	Use the left and right arrow keys to adjust the volume
	Audio In Levels	Use the left and right arrow keys to adjust the volume
	Audio Source	Built-in microphone/Line in
	Zoom Limit	Set the Zoom magnification
	Auto Power On	Powers on automatically when connected to power supply
	IP Address	Display the IP address (If it is not connected to a router, the default IP is 192.168.100.100)
Advanced	Language	Support multi-language (default is English)
	Lock Down	Enable/Disable lock down Select [Enable] to set the password.
	Auto Erase	Enable/Disable Auto Erase When [On] is selected, the stored images will automatically be deleted when the system is turned off
	Preset Load	Load the stored settings Use the left and right arrow keys to select, and then confirm by pressing [ENTER]
	Preset Save	Store the value of the current image mode Use the left and right arrow keys to select, and then confirm by pressing [ENTER]
	Splash Screen Settings	Launch [Splash Screen Settings] window
	Factory Reset	Use the left and right arrow keys to select, and then confirm by pressing [ENTER] to restore the factory defaults
	Firmware Version	Show the firmware version

5.2.3 Mask Mode setting menu

Function Items	Function Descriptions
Live	Press [ENTER] to return to the live image.
Transparency	Use the left and right arrow keys to adjust the transparency of the mask.
Step	Use the left and right arrow keys to select the step of the mask.
V Size	Use the left and right arrow keys to select the vertical height of the mask.
H Size	Use the left and right arrow keys to select the horizontal length of the mask.
Exit	Press [ENTER] to confirm your selection and exit the mask mode setting menu.

5.2.4 Spotlight Mode setting menu

Function Items	Function Descriptions
Live	Press [ENTER] to return to the live image.
Shape	Use the left and right arrow keys to select the shape of the spotlight zone.
Transparency	Use the left and right arrow keys to adjust the transparency of the border in the spotlight mode.
Step	Use the left and right arrow keys to select the step of the spotlight zone.
V Size	Use the left and right arrow keys to adjust the height of the spotlight zone.
H Size	Use the left and right arrow keys to adjust the width of the spotlight zone.
Exit	Press [ENTER] to confirm your selection and exit the spotlight mode setting menu.

5.2.5 Splash Screen Setting







Function Items	Function Descriptions
Power On Image Setting	Select to default/custom power on image
Power On Logo Show Time	Set the duration of displaying the power on logo that can be adjusted between 4 ~ 30 seconds
Power On Image Select	Power On Image Select × Only pictures in JPEG format are supported
Exit	Press [ENTER] to confirm your selection and exit splash screen setting window

5.2.6 Annotation Tools

After connecting the mouse via USB, right-click to activate the  drawing function of the setting menu

When the mouse stays at the right side of the screen, the mouse annotation menu can be activated

※ Choose either USB screen or Mouse Annotation. If you want to use Mouse Annotation function, please remove the USB cable.

Icon	Description	Icon	Description
	Custom tool 1		Clear all
	Custom tool 2		Open setting menu of the annotation tool
	Eraser		Exit the annotation tool

Chapter 6 Descriptions of Major Functions

6.1 Automatically adjust the image to have the best brightness and focusing performance

Press [AUTO TUNE]  on the remote control or control panel to adjust to the optimal brightness and focal length.



6.2 Switch Image Sources

The default image source is Live Image. Press [SOURCE]  to change the setting, and the output screen will switch between Live Image (default)/HDMI IN.

6.3 Make text clearer and photos more colorful

- Go to the setting menu, select [Photo/Text] > [Photo/Text/Gray].
 - [Photo] (default): for viewing photos or text with photos, making photos more colorful.
 - [Text]: for viewing text files, making the text clearer.
 - [Gray]: for viewing black & white photos which will make the grayscale differentiation distinct.
- Press [MENU] to exit.

6.4 Rotate Image

- Remote control: Press [ROTATE]  key to rotate the screen.
- Control panel: Go to the setting menu, select [Rotate]  to change the rotation method.

※ The following functions are not available when the image is rotated:
PAN/PIP/Recording.

6.5 Capture Image

Press [CAPTURE/DEL]  to capture and save images.

※ You cannot capture images when the capture mode is set to [Disable]. If it is set to [Continuous], you can capture images continuously by pressing [CAPTURE/DEL] , or press again to exit.

※ To change the quality of images, go to the setting menu [Settings] > [Capture] > [Image Quality] to do the setting.

6.6 Record



※ Connect USB disk to PS753 to start recording images.

※ You may not be able to capture or record images when [Capture Image] mode is set to [Disable].



- Press [RECORD]  to record videos.
- Record sounds with the built-in microphone of the control panel.

3. Press [RECORD]  again to stop recording.

6.7 View captured/recorded images

1. Press [PLAYBACK]  to show the thumbnails of all stored files.
2. Select the thumbnail you want to play and press [ENTER] to play.
3. When playing the video, press [FREEZE]  to pause/play the video or press [ENTER] to stop playing.
4. Press [▶] or [◀] to select the next or previous audio/video file.
5. Press [▲] or [▼] to adjust the volume of the video.
* An external speaker must be connected to AUDIO OUT to play sound when you use VGA OUT.

6.8 Delete captured/recorded images

1. Press [PLAYBACK]  to show the thumbnails of all stored files.
2. After selecting the file to be deleted, press [CAPTURE/DEL]  to show the [Delete File] window.
3. Select [Yes], press [ENTER] to delete the selected file.

6.9 Adjust the output volume



* Volume control is intended to control the external audio output equipment only.

In PLAYBACK mode, Press [▲] or [▼] to adjust the volume of the video.

6.10 Automatically delete the stored images whenever it is turned off (Auto Erase)

1. Go to the setting menu, select [Settings] > [Advanced] > [Auto Erase] > [On].
2. Press [MENU] to exit.

6.11 Enlarge a part of the image (PAN)

1. Enable the partial enlarged mode.
 - Remote control: Press [PAN]  to enable the partial enlarged mode.
 - Control panel: Go to the setting menu, select [PAN] , and press [ENTER] for execution.
2. Press [▲],[▼],[◀], or [▶] to move and view the partial enlarged images.
3. Press [MENU] to exit the partial enlarged mode.

6.12 I would like to use the MASK and Spotlight function

6.12.1 Use the mask or spotlight mode

▪ Use remote control:

1. Press [MASK]  key to enter the Mask/Spotlight mode menu.
Press [◀] or [▶] to select mode.
2. Press [ENTER] to enter the Mask or Spotlight mode.
3. Press [▲],[▼],[◀], or [▶] to move the zone position.

4. Press [MASK]  again to return to the live image.

■ Use **control panel**:

1. Go to the setting menu, select [Mask] , and press [ENTER] to enter the Mask or Spotlight mode.
2. Press [▲],[▼],[◀], or [▶] to move the zone position.
3. Go to the setting menu, select [Live image], and press [ENTER] to return to the live image.

6.12.2 I would like to set the size of Mask/Spotlight function

In Mask/Spotlight mode, use the **remote control or control panel**:

1. Go to the setting menu, select the item to be changed.
 - Mask mode: [Transparency/Step/V Size/H Size].
 - Spotlight mode: [Shape/Transparency/Step/V Size/H Size].**(For details, please refer to [5.2 Setting Menu.](#))**
2. Press [MENU] to exit the Setting Menu and return to Mask/Spotlight mode.

6.13 Play the slides (Slide Show)

6.13.1 Setting delay time

1. Go to the setting menu, select [Settings] > [Storage] > [Delay], and select the delay time.
2. Press [MENU] to exit.

6.13.2 Playing/Pausing/Stopping the slide show

※ Upper limit: The maximum size of single photo is 7 MB.

1. Go to the setting menu, select [Settings] > [Storage] > [Slide Show] > [ENTER] for execution.
2. Press [ENTER] again to pause/play.

6.14 Use a USB disk



Insert the USB disk and a [Copy To USB disk] dialog box will appear, and you are asked whether to copy files from PS753 to the USB disk. Press [▶] or [◀] to select.



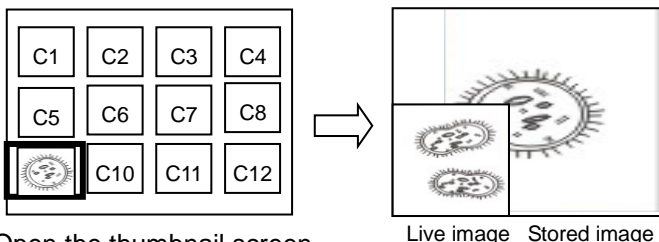

6.15 Image comparison (to compare live images with stored image files (PIP))

This function will compare and contrast a live image with a stored image.



1. Open the thumbnail screen.
 - Remote control: Press [Playback]  to access the thumbnail screen, and select the image files to be compared.
 - Control panel: Press [MENU] to go to the setting menu, select [PIP] , and choose the image files to be compared.
2. Press [\blacktriangle],[\blacktriangledown],[\blacktriangleleft], or [\blacktriangleright] to move the live image.
3. Repeat Step 1 to change other image files.
4. Press [MENU] to exit.

6.16 Lock/Unlock keys

Press[ENTER]  + [LAMP]  buttons on the panel for 2 seconds to enable the Lock function.

Repeat the action again to unlock.

※ This function is only valid for the panel buttons, the remote control can still operate normally. When turning off with the remote control, the lock function will be released automatically after rebooting.

6.17 Change the power on image

1. Go to the setting menu, select [Settings] > [Advanced] > [Splash Screen Settings].
2. Select [Default/Custom].
 - 2.1 If you select [Custom], you can set the [Power On Logo Show Time] and [Select Splash Screen].
 - ※ The power on image file must be less than 5 MB and in JPEG format.
 - ※ To save the file, please follow the instruction below:
 - File path: \DCIM\100MEDIA, for example: J:\DCIM\100MEDIA
 - File name: four English letters+ four numbers, for example: LUMN0001.JPG
3. Press [\blacktriangledown] to [Exit] and press [ENTER] to exit.

Chapter 7 Network Function Settings

Description

7.1 Connecting Camera to Internet

Two common connection methods are shown below

1. Connecting via switch or router

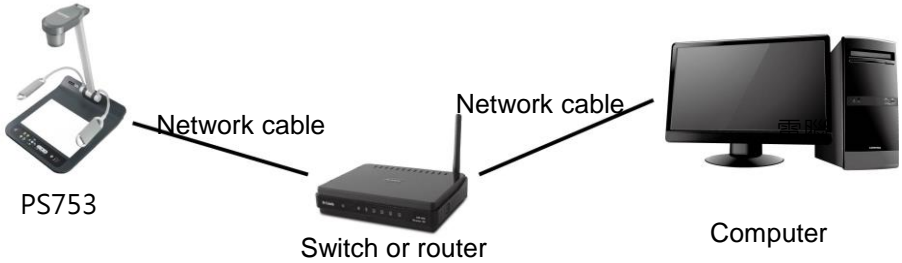

2. To connect directly through network cable, the IP address of the computer should be changed so that it is on the same network segment as the camera

E.g.: The factory-preset default IP address of PS753 is 192.168.100.100. The computer IP address must be set with the same network segment, such as 192.168.100.101, so that the computer can be connected correctly with the camera

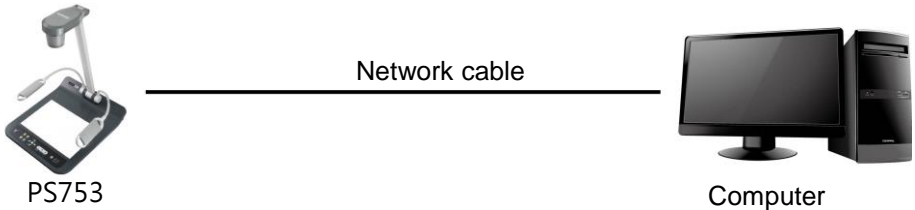

- Change network settings

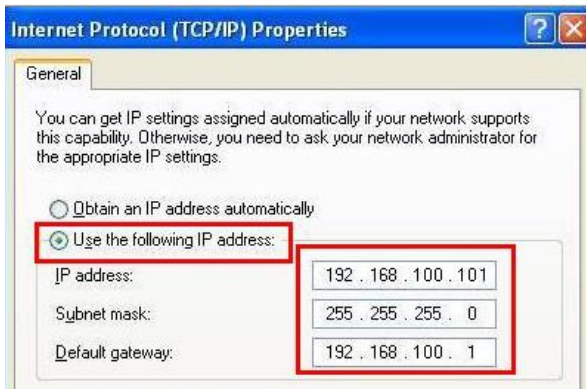

7.2 Using the Browser to View the Images

1. DHCP is enabled by default. You can view the IP location from Menu > Settings > Control.

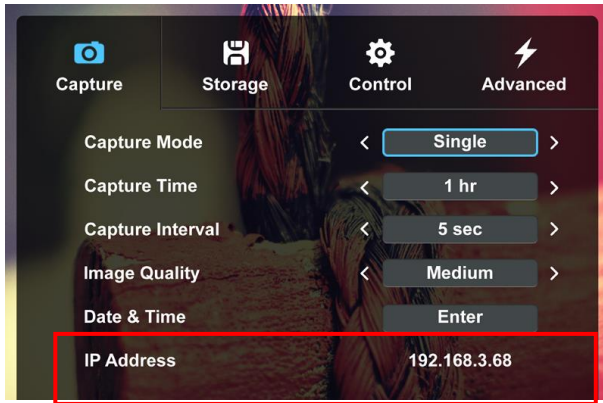

2. Open the browser, and enter the IP address in the address bar (If it is not connected to a router, the default IP is 192.168.100.100)



3. Enter the account and password to view the images and control PS753

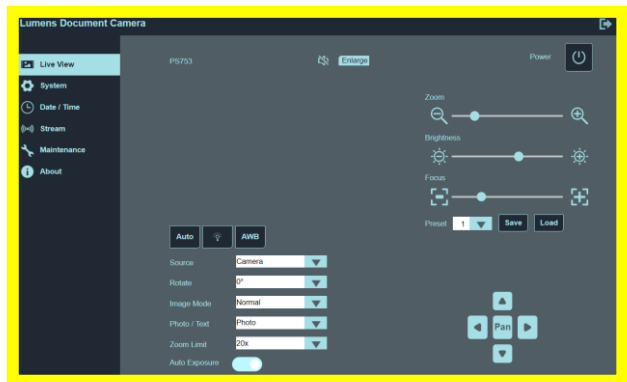
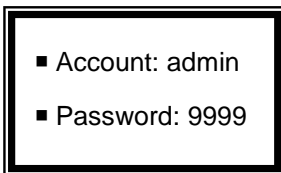

7.3 Using RTSP Player to View the Images

- RTSP connections can be made using free software, e.g.: VLC, Quick Time, PotPlayer, etc
- RTSP connection address formats are as follows: `rtsp://camera IP:8557/h264`
- For password authentication, the RTSP connection address is as follows:
`rtsp:// Username: Password@camera IP:8557/h264`

<Remark> To enable password authentication, please refer to [7.4.6 Streaming Setting](#)

- Example:
Open the VLC software, select [Media] > [Open Network Streaming], and enter the URL:
`rtsp://192.168.4.28:8557/h264`

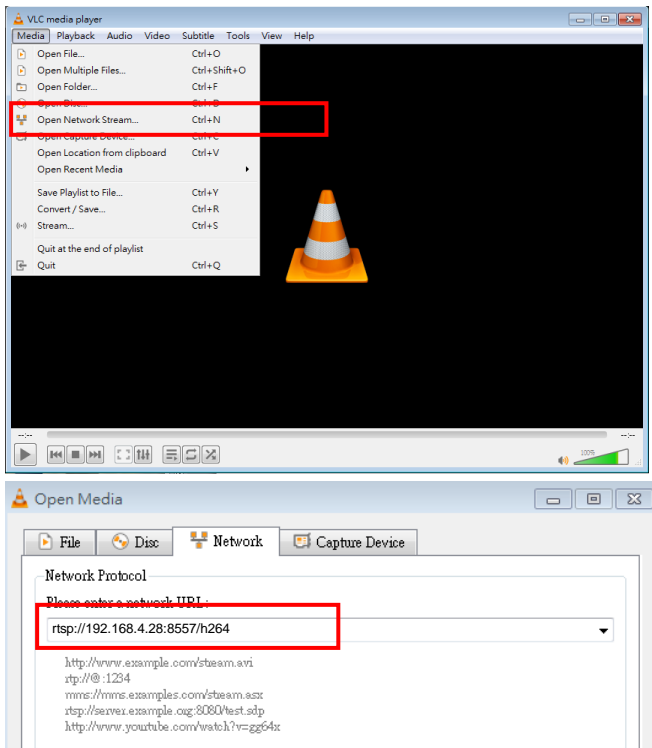

7.4 Web Page Menu Function Description

7.4.1 Login Screen

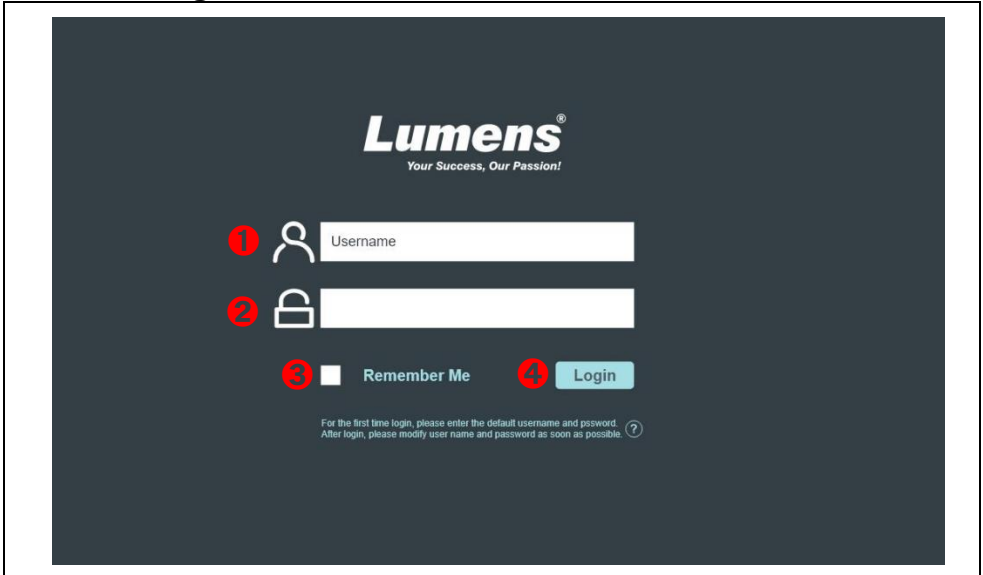

No	Item	Function Descriptions
1	User Login Account	Enter user login account (default: admin)
2	User Password	Enter user password (default: 9999) * For the first-time login, please refer to 7.4.4 System Settings to change the default password
3	Remember user account and password	Save user login account and password to the browser. When you log in next time, there is no need to re-enter them
4	Login	Log into the administrator screen on the website

7.4.2 Live View-1

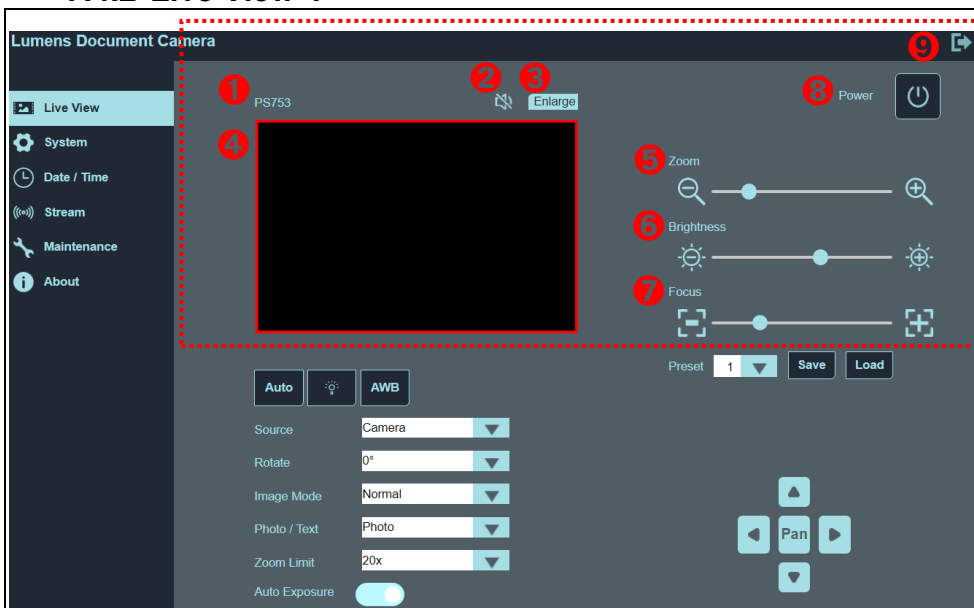

No	Item	Function Descriptions
1	Camera ID	Display the device name
2	Mute	Turn on/off web audio output
3	Enlarge	Switch the preview window to full screen
4	Preview window	Display the screen currently captured by PS753
5	Zoom	Zoom in/out images
6	Brightness	Brightness
7	Focus	Tune the focus
8	Power	Enable/Disable PS753
9	Logout	Log out of the web page

7.4.3 Live View-2

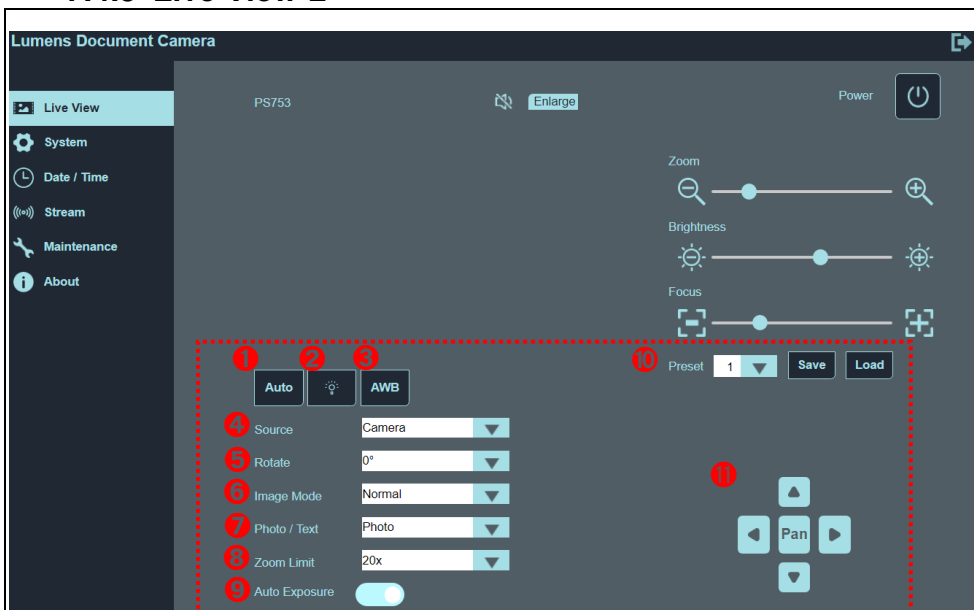

No	Item	Function Descriptions
1	Auto Tune	Automatic Image Optimization; automatically adjust the image to have the best brightness and focal length
2	Lamp	Click lamp mode toggle switch: off / brightness 1 / brightness 2 / brightness 3
3	AWB	Execute Auto White Balance once
4	Source	Camera/HDMI In screen switching
5	Rotate	Rotate the image: 0°/90°/180°/270°/Flip/Mirror
6	Image Mode	Select Image Mode Normal/Film/Slide/Microscope
7	Photo / Text	Select Photo/Text/Gray Mode
8	Zoom Limit	Set the Zoom magnification
9	Auto Exposure	Enable/disable auto exposure
10	Preset	Set Preset Save: Store the value of the current image mode Load: Load the stored settings
11	Pan	Turn on/off partial digital enlarge Arrow keys can move the screen

7.4.4 System settings

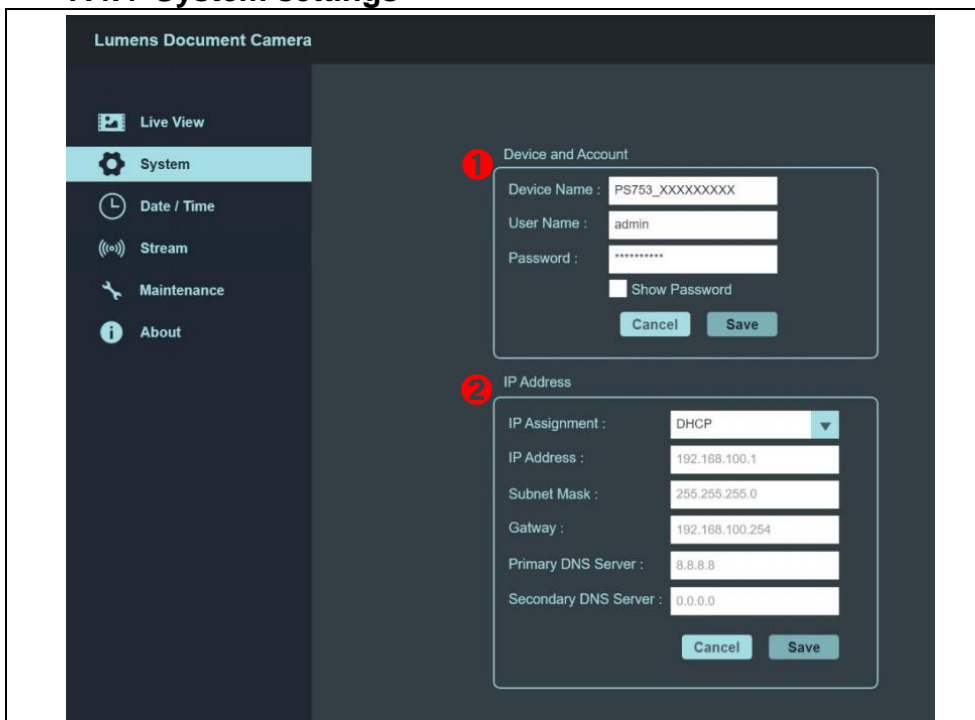

No	Item	Function Descriptions
1	Device and Account	<p>Display the current device name of PS753 and web login settings.</p> <p>You can change the device name, user account and password, click [Save] to save the settings, and click [Cancel] to cancel the changes.</p> <ul style="list-style-type: none"> ※ The name is limited to 1 - 16 characters ※ Please use a camera name by mixing uppercase and lowercase letters or numbers. Do not use “/” and “space” or special symbols
2	IP Address	<p>Ethernet Setting.</p> <p>When it is set to Static IP, the setting can be modified.</p>

7.4.5 Date/Time Settings

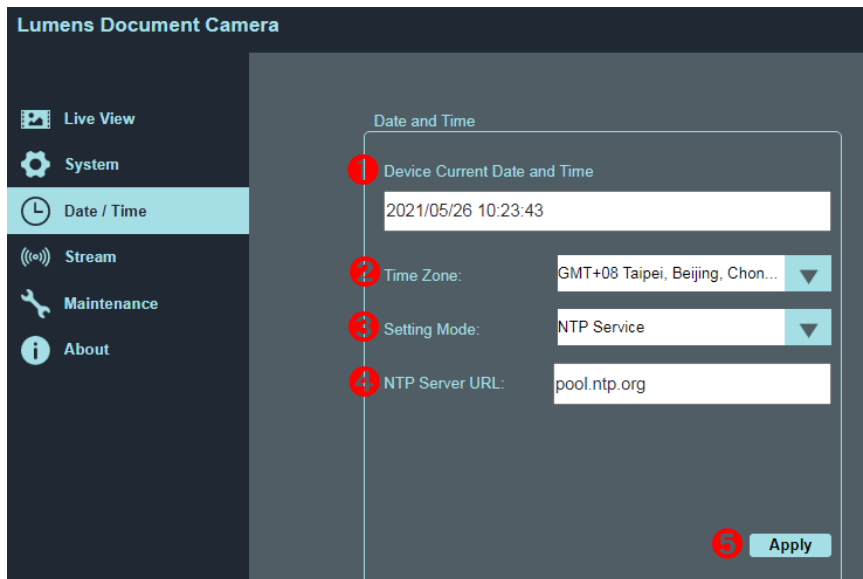

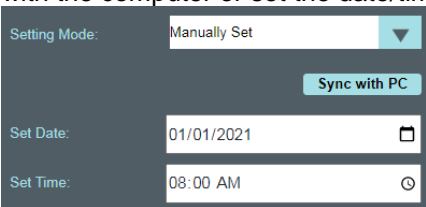
No	Item	Function Descriptions
1	Device Current Date and Time	Display the current system time
2	Time Zone	Set the Time Zone.
3	Setting Mode	<p>Select NTP Service/Manually Set Turn on Manually Set and choose to synchronize with the computer or set the date/time manually.</p> 
4	NTP Server URL	NTP service to display this item Connect to a NTP server to correct time
5	Apply	Apply your settings

7.4.6 Streaming Setting

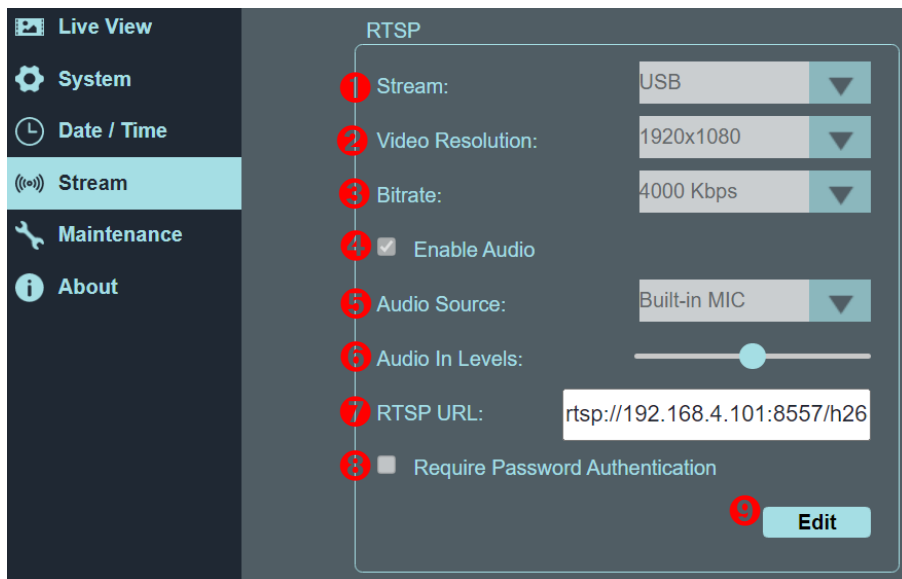

No	Item	Function Descriptions
1	Stream	Switch Ethernet or USB function ※ Ethernet/USB may only choose one, because they cannot be output at the same time
2	Video Resolution	Show or set the RTSP output resolution and fps
3	Bitrate	Display or set the bit rate of RTSP
4	Enable Audio	Turn on/off RTSP audio
5	Audio Source	Select the audio source
6	Audio In Levels	Adjust the volume
7	RTSP URL	Display current RTSP URL
8	Require Password Authentication	Enable/Disable RTSP password authentication
9	Edit	Enter Edit mode

7.4.7 Maintenance

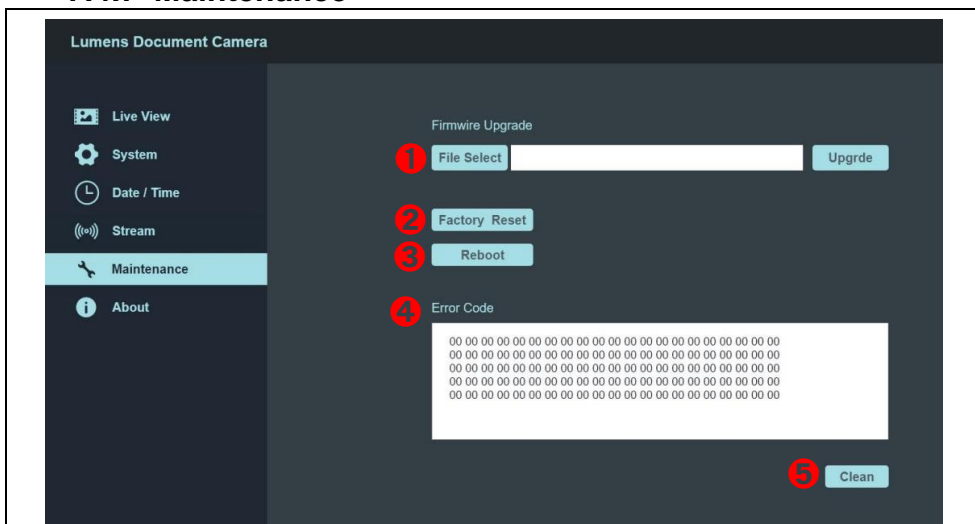

No	Item	Function Descriptions
1	Firmware Upgrade	Select the firmware file, and click [Upgrade] to update the firmware ※ Update takes about 1 - 2 minutes ※ Please do not operate or turn off the power of the device during the update to avoid firmware update failure
2	Factory Reset	Restore the factory default (software)
3	Reboot	Restart
4	Error Code	Display system Error code ※ When an error code appears, the user may try to clear and confirm if the error will repeat itself
5	Clean	Clear Error code

Chapter 8 Connecting to Microscope

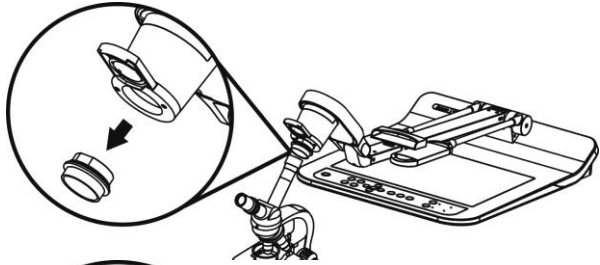

- 1 Mount the **microscope adapter** onto the microscope
 - ※ Please choose an appropriate microscope adapter for eyepieces size of $\varnothing 28$ mm, $\varnothing 31$ mm, $\varnothing 33$ mm, and $\varnothing 34$ mm.
- 2 The lens of PS753 connects with the **microscope adapter**

For eyepieces of $\varnothing 33$ mm or $\varnothing 34$ mm, only one microscope adapter (with the greatest diameter) is needed.

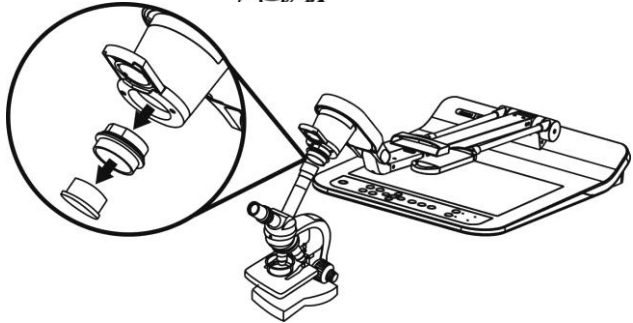

For eyepieces of $\varnothing 28$ mm or $\varnothing 31$ mm, fit one microscope adapter with the greatest diameter along with another appropriate one.



- 3 Select the **[Microscope]** mode
 - Press [MENU]  to enter the Service Menu, and select [Image Mode] > [Microscope].
- 4 If the image is not clear
 - Please adjust the focus of microscope
 - Press [AUTO TUNE]  to activate the auto focus
- 5 Please reset to normal mode after using the microscope.
 - Press [MENU]  to enter the Service Menu, and select [Image Mode] > [Normal].

Chapter 9 Packing the Machine

1. Put the remote control back to the holder.
2. Fold back the camera head to align with the arm.
3. Turn the two lamp arms and the arm of camera head down and adjust them to be parallel with the platform.
4. Put the lens cap on the camera head.
5. Finally, fold the machine as in the following figure.

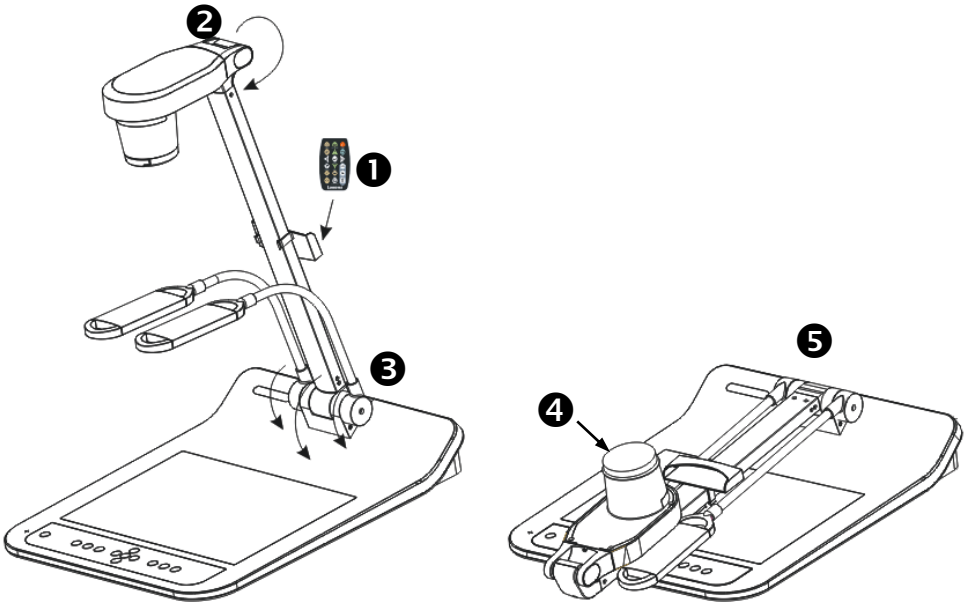

Chapter 10 DIP Switch Setting

※ You should unplug and reconnect the power cord, and then restart the PS753 for all DIP switching to take effect.

1. Description of DIP

DIP	Function Descriptions
1	Output Resolution
2	
3	OFF (Normal mode): 30 fps, applicable to general scene ON (High-speed mode): 60 fps, applicable to support rapidly changing scene (4K resolution not available)
4	OFF: 60 Hz ON: 50 Hz
5	Reserved, no function
6	Reserved, no function



2. HDMI Resolution

Resolution	60Hz	50Hz
1920 x 1080	Off: [DIP 1: On] [DIP 2: On] [DIP 3: On] [DIP 4: On] [DIP 5: On] [DIP 6: On] On: [DIP 1: Off] [DIP 2: Off] [DIP 3: Off] [DIP 4: Off] [DIP 5: Off] [DIP 6: Off]	Off: [DIP 1: On] [DIP 2: On] [DIP 3: On] [DIP 4: Off] [DIP 5: On] [DIP 6: On] On: [DIP 1: Off] [DIP 2: Off] [DIP 3: Off] [DIP 4: On] [DIP 5: Off] [DIP 6: Off]
3840 x 2160	Off: [DIP 1: On] [DIP 2: On] [DIP 3: On] [DIP 4: On] [DIP 5: On] [DIP 6: On] On: [DIP 1: Off] [DIP 2: On] [DIP 3: On] [DIP 4: On] [DIP 5: On] [DIP 6: On]	Off: [DIP 1: On] [DIP 2: On] [DIP 3: On] [DIP 4: On] [DIP 5: On] [DIP 6: On] On: [DIP 1: Off] [DIP 2: On] [DIP 3: On] [DIP 4: On] [DIP 5: On] [DIP 6: On]
1280 x 720	Off: [DIP 1: On] [DIP 2: On] [DIP 3: On] [DIP 4: On] [DIP 5: On] [DIP 6: On] On: [DIP 1: On] [DIP 2: Off] [DIP 3: On] [DIP 4: On] [DIP 5: On] [DIP 6: On]	Off: [DIP 1: On] [DIP 2: On] [DIP 3: On] [DIP 4: On] [DIP 5: On] [DIP 6: On] On: [DIP 1: On] [DIP 2: Off] [DIP 3: On] [DIP 4: On] [DIP 5: On] [DIP 6: On]
1024 x 768	Off: [DIP 1: On] [DIP 2: On] [DIP 3: On] [DIP 4: On] [DIP 5: On] [DIP 6: On] On: [DIP 1: On] [DIP 2: Off] [DIP 3: On] [DIP 4: On] [DIP 5: On] [DIP 6: On]	Off: [DIP 1: On] [DIP 2: On] [DIP 3: On] [DIP 4: On] [DIP 5: On] [DIP 6: On] On: [DIP 1: On] [DIP 2: Off] [DIP 3: On] [DIP 4: On] [DIP 5: On] [DIP 6: On]

※ For the corresponding resolution of RTSP/UVC, please refer to [Appendix 2 Resolution Comparison](#).

Chapter 11 Troubleshooting

This chapter describes problems you may encounter while using PS753. If you have questions, please refer to related chapters and follow all the suggested solutions. If the problem still occurred, please contact our distributors or service center.

No.	Problems	Solutions
1	Boot without power signal	Make sure you have plugged in the power cord.
2	There is no image output from PS753	<ol style="list-style-type: none"> 1. Check the power. 2. Check all cable connections. Refer to Chapter 3 Installation and Connections in this manual. 3. Check the [Source], refer to 6.2 Switch Image Sources of Chapter 6 Descriptions of Major Functions. 4. Check the settings for the source of the projector. Please refer to the user manual of the projector. 5. Check if DIP switch is properly set. Please refer to Chapter 10 DIP Switch Setting in this manual for related settings.
3	No Ethernet/USB Image Output	<p>Ethernet/USB may only choose one, because they cannot be output at the same time. Please switch the streaming settings on the setting menu or web page</p> <ul style="list-style-type: none"> ■ Setting Menu: [Settings] > [Capture] > [Streaming] > [Ethernet/USB] ■ Web page: [Stream] > [Stream] > [Ethernet/USB]
4	Unable to focus	Probably the document is too close. Press the [ZOOM -]  button or pull away the distance between the lens and the document, and then press [AUTO TUNE]  to auto-focus.
5	The image is incomplete	Check the Auto Image setting of your projector. Please refer to the user manual of the projector or check for the DIP Switch resolution setting.
6	No screen with Ladibug software	<ol style="list-style-type: none"> 1. Change the USB cable. 2. Please try the USB port on the back of the computer or other USB port. 3. Please close the currently running applications and then start Ladibug software. If other software is already using PS753 images, Ladibug software cannot output the screen.
7	When PS753 is turned on, the auxiliary floodlight do not light	Please press [Lamp]  to switch the lamp source.

No.	Problems	Solutions
8	PS753 fails to store images or react	<ol style="list-style-type: none"> 1. Check to see if the stored data have reached the maximum size of the USB disk (priority) or internal memory. 2. Please make sure if the capture function is set to continuous mode or the time for capture is set to be long.
9	The output image is too bright, too dark, or vague	Press [AUTO TUNE] button to automatically adjust the image to have the best brightness and focusing performance.
10	Unable to record images	<ol style="list-style-type: none"> 1. Check to see if the stored data have reached the maximum size of the USB disk. 2. The recording function is not supported in the internal memory. Please make sure that USB disk is inserted.
11	The operating steps in the manual are not applicable to the machine	<p>The operating steps in the manual may be not applicable to the machine due to improvement in functions. Check to see if the Firmware version of your machine is up-to-date.</p> <ol style="list-style-type: none"> 1 Please go to Lumens official website to check whether the latest version is available for update. https://www.MyLumens.com/support 2 Firmware version confirmation steps: Go to the setting menu, and select [Settings] > [Advanced] > [Firmware Version].
12	How to unlock the locked device	<ol style="list-style-type: none"> 1. Go to the setting menu and select [Settings] > [Advanced] > [Lock Down]. 2. Cancel the password setting function.
13	When using the USB cable to connect to a computer, HDMI IN screen output is not available through USB	After using the USB cable to connect to a computer, only Live Image output is available.
14	There is rippling on the output image	Please refer to the Appendix 1 in the manual to confirm the applicable voltage frequency, and reset it according to the instruction in Chapter 10 DIP Switch Setting .
15	The data in the USB disk cannot be read	<ol style="list-style-type: none"> 1. The USB disk with the capacity of 4 G and above is recommended (up to 4 TB supported). 2. Make sure the file is saved at the specified path: \DCIM\100MEDIA. (E.g.: J:\ DCIM\100MEDIA) 3. Make sure the file is named appropriately, e.g. four English letters + four numbers. (E.g.: LUMN0001.JPG)

Chapter 12 Safety Instructions

Always follow these safety instructions when setting up and using the Document Camera:

1 Operation

- 1.1 Please use the product in the recommended operating environment, away from water or source of heat.
- 1.2 Do not place the product on a tilted or unstable trolley, stand or table.
- 1.3 Do not block the slots and openings in the case of the product. They provide ventilation and prevent the product from overheating.
- 1.4 Do not open or remove covers, otherwise it may expose you to dangerous voltages and other hazards. Refer all servicing to licensed service personnel.
- 1.5 Unplug the product from the wall outlet and refer servicing to licensed service personnel when the following situations happen:
 - If the USB port becomes damaged or frayed.
 - If liquid is spilled into the product or the product has been exposed to rain or water.

2 Installation

- 2.1 For security considerations, please make sure the standard mount you use is in line with UL or CE safety approbations and installed by technician personnel approved by agents.

3 Storage

- 3.1 Do not place the product where the cord can be stepped on as this may result in fraying or damage to the lead or the plug.
- 3.2 Remove the USB cable during thunderstorms or when the product is not used for a long time.
- 3.3 Do not place this product or accessories on top of vibrating equipment or heated objects.



4 Cleaning

- 4.1 Disconnect all the cables prior to cleaning and wipe the surface with a dry cloth. Do not use alcohol or volatile solvents for cleaning.

5 Batteries (for products or accessories with batteries)

- 5.1 When replacing batteries, please only use similar or the same type of batteries
- 5.2 When disposing of batteries or products, please adhere to the relevant instructions in your country or region for disposing of batteries or products

■ Precautions

	This symbol indicates that this equipment may contain dangerous voltage which could cause electric shock. Do not remove the cover (or back). No user-serviceable parts inside. Refer servicing to licensed service personnel.		This symbol indicates that there are important operating and maintenance instructions in this User Manual with this unit.
---	---	---	---

■ FCC Warning (A)

This equipment has been tested and found to comply with the limits for a Class A digital device, pursuant to part 15 of the FCC Rules. These limits are designed to provide reasonable protection against harmful interference when the equipment is operated in a commercial environment.

Notice :

The changes or modifications not expressly approved by the party responsible for compliance could void the user's authority to operate the equipment..

This equipment has been tested and found to comply with the limits for a Class A digital device, pursuant to part 15 of the FCC Rules. These limits are designed to provide reasonable protection against harmful interference when the equipment is operated in a commercial environment.

■ IC Warning

This digital apparatus does not exceed the Class A limits for radio noise emissions from digital apparatus as set out in the interference-causing equipment standard entitled "Digital Apparatus," ICES-003 of Industry Canada.

Cet appareil numérique respecte les limites de bruits radioélectriques applicables aux appareils numériques de Classe A prescrites dans la norme sur le matériel brouilleur: "Appareils Numériques," NMB-003 édictée par l'Industrie.

■ EN55032 CE Warning

Operation of this equipment in a residential environment could cause radio interference.

Warning: Operation of this equipment in a residential environment may cause radio interference

Supplier's Declaration of Conformity

47 CFR § 2.1077 Compliance Information

Manufacturer : Lumens Digital Optics Inc.

Product Name : PS753

Model Number : Document Camera

Responsible Party – U.S. Contact Information

Supplier : Lumens Integration, Inc.

4116 Clipper Court, Fremont, CA 94538, United States

e-mail : support@mylumens.com

FCC Compliance Statement







This device complies with Part 15 of the FCC Rules. Operation is subject to the following two conditions : (1) This device may not cause harmful interference, and (2) this device must accept any interference received, including interference that may cause undesired operation.



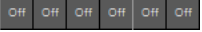
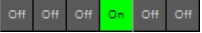

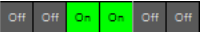
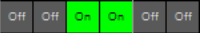

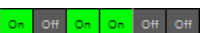
Appendix 1 Power frequency for each country in the world

Region or Country	Frequency	Region or Country	Frequency	Region or Country	Frequency
English		English		English	
Afghanistan	50	China	50	Guam	60
Algeria	50	Colombia	60	Grenada	50
Angola	50	Congo	50	Guatemala	60
Antigua	50	Costa Rica	60	Guinea	50
Argentina	50	Cuba	60	Gayana	50
Australia	50	Cyprus	50	Haiti	60
Austria	50	Czechoslov-akia	50	Hawaii	60
Azores	50	Dahomey	50	Honduras	60
Bahamas	60	Den mark	50	Hong Kong	50
Bahrain	60	Dominican	60	Hungary	50
Bangladesh	50	Dubai	50	Ice land	50
Babados	50	Ecuador	60	India	50
Belgium	50	Egypt	50	Indonesin	50
Bermuda	60	El Salvador	60	Iran	50
Bolivia	50	Equatorial Guinea	50	Iraq	50
Botswana	50	Ethiopia	50	Ireland	50
Brazil	50 60	Faeroe Island	50	Isle of Man	50
Bulgaria	50	Fiji	50	Israel	50
Burma	50	Finland	50	Italy	50
Burundi	50	France	50	Ivory Coast	50
Cambodia	50	French Guiana	50	Jamaica	50
Cameroon	50	Gabon	50	Japan	50 60
Canada	60	Gambia	50	Jordan	50
CanaryIsland	50	Germany	50	Kenya	50
Central Africa Rep.	50	Ghana	50	Korea	60
Ceylon	50	Gibraltar	50	Kuwait	50
Chad	50	Great Britain	50	Lebanon	50
Channel Island	50	Greece	50	Lesotho	50
Chile	50	Greenland	50	Liberia	60
Libya	50	Oman	50	Syria	50
Luxembourg	50	Pakistan	50	Tahiti	60
Macao	50	Panama	60	R.O.C. Taiwan	60
Madeiral	50	Paraguay	50	Tanzania	50
Majokca Island	50	Peru	60	Thailand	50
Malagasy	50	Philippines	60	Togo Rep.of	50
Malawi	50	Poland	50	Tonga	50
Malaysia	50	Portugal	"	Trinidad	60

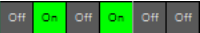
Region or Country	Frequency	Region or Country	Frequency	Region or Country	Frequency
English		English		English	
Mali Rep.	50	Puerto Rico	60	Tobago	60
Malta	50	Qatar	50	Tunisia	50
Martinique	50	Rhodesia	50	Turkey	50
Mauritania	50	Romania	50	Uganda	50
Mauritius	50	Rwanda	50	USA.	60
Mexico	60	Saudi Arabia	50 60	USSR	50
Monaco	50	Scotland	50	United Kingdom	50
Montserrat	60	Senegal	50	Upper Volta	50
Morocco	50	Sierra Leone	50	Uruguay	50
Mozambique	50	Singapore	50	Venezuela	60
Nepal	50	Somalia	50	Viet-Nam	50
Netherlands	50	South Africa Rep.	50	Virgin Island	60
New Caledonia	50	Spain	50	Western Samoa	50
New Zealand	50	Sri Lanka	50	Yeman(Aden)	50
Nicaragua	60	Sudan	50	Yemen(Arab)	50
Niger	50	Surinam	60	Yugoslavia	50
Nigeria	50	Swaziland	50	Zaire Rep. of	50
Norway	50	Sweden	50	Zambia	50
Okinawa	60	Switzerland	50		

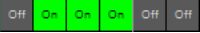
Appendix 2 Resolution Comparison

Dip Switch	HDMI Output	Mode	FPS	RTSP	UVC				
				H264	H264	MJPEG	YUV		
	1920x1080 60Hz	Normal	30	3840x2160	3840x2160	NA	NA		
				1920x1080 (Default)	1920x1080	1920x1080			
				1280x720	1280x720	1280x720			
							640x360	NA	640x360
	1920x1080 50Hz	Normal	25	3840x2160	3840x2160	NA	NA		
				1920x1080 (Default)	1920x1080	1920x1080			
				1280x720	1280x720	1280x720			
							640x360	NA	640x360
	1920x1080 60Hz	High	60	NA	1920x1080	NA	NA		
				1280x720	1280x720				
		Speed	30	1920x1080	1920x1080	1920x1080	NA		
				1280x720	1280x720	1280x720			
							640x360	640x360	640x360
	1920x1080 50Hz	High	50	NA	1920x1080	NA	NA		
				1280x720	1280x720				
		Speed	25	1920x1080	1920x1080	1920x1080	NA		
				1280x720	1280x720	1280x720			
							640x360	640x360	640x360
	3840x2160 30 Hz	Normal	30	1920x1080	1920x1080	1920x1080	NA		
				1280x720	1280x720	1280x720			
							640x360	NA	640x360
	3840x2160 25 Hz	Normal	25	1920x1080	1920x1080	1920x1080	NA		
				1280x720	1280x720	1280x720			
							640x360	NA	640x360
	1920x1080 60Hz	High	60	NA	1920x1080	NA	NA		
				1280x720	1280x720				
		Speed	30	1920x1080	1920x1080	1920x1080	NA		
				1280x720	1280x720	1280x720			
							640x360	640x360	640x360
	1920x1080 50Hz	High	50	NA	1920x1080	NA	NA		
				1280x720	1280x720				
		Speed	25	1920x1080	1920x1080	1920x1080	NA		
				1280x720	1280x720	1280x720			
							640x360	640x360	640x360
	1280x720	Normal	30	3840x2160	3840x2160	NA	NA		
				1920x1080	1920x1080	1920x1080			
				1280x720	1280x720	1280x720			

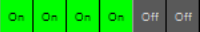
Dip Switch	HDMI Output	Mode	FPS	RTSP	UVC		
				H264	H264	MJPEG	YUV
	60 Hz			640x360	NA	640x360	640x360
	1280x720	Normal	25	3840x2160	3840x2160	NA	NA
				1920x1080	1920x1080	1920x1080	
				1280x720	1280x720	1280x720	
	50 Hz				640x360	640x360	640x360
	1280x720	High Speed	60	NA	1920x1080	NA	NA
					1280x720		
					NA		
	60 Hz		30	1920x1080	1920x1080	1920x1080	NA
				1280x720	1280x720	1280x720	NA
				640x360	NA	640x360	640x360
	1280x720	High Speed	50	NA	1920x1080	NA	NA
					1280x720		
					NA		
	50 Hz		25	1920x1080	1920x1080	1920x1080	NA
				1280x720	1280x720	1280x720	NA
				640x360	NA	640x360	640x360
	1024x768	Normal	30	1024x768	1024x768	1024x768	NA
	60 Hz			640x480	NA	640x480	640x480
	1024x768	Normal	25	1024x768	1024x768	1024x768	NA
	60 Hz			640x480	NA	640x480	640x480
	1024x768	High Speed	60	NA	1024x768	NA	NA
					NA		
	60 Hz		30	1024x768	1024x768	1024x768	NA
				640x480	NA	640x480	640x480
	1024x768	High Speed	50	NA	1024x768	NA	NA
					NA		
	60 Hz		25	1024x768	1024x768	1024x768	NA
				640x480	NA	640x480	640x480

Copyright Information

Copyrights © Lumens Digital Optics Inc. All rights reserved.

Lumens is a trademark that is currently being registered by Lumens Digital Optics Inc.

Copying, reproducing or transmitting this file is not allowed if a license is not provided by Lumens Digital Optics Inc. unless copying this file is for the purpose of backup after purchasing this product.

In order to keep improving the product, Lumens Digital Optics Inc. hereby reserves the right to make changes to product specifications without prior notice. The information in this file is subject to change without prior notice.

To fully explain or describe how this product should be used, this manual may refer to names of other products or companies without any intention of infringement.

Disclaimer of warranties: Lumens Digital Optics Inc. is neither responsible for any possible technological, editorial errors or omissions, nor responsible for any incidental or related damages arising from providing this file, using, or operating this product.